



L3IP4TS L3IP4TS4 L3PI4TFC5
L3IP8TS L3IP8TS4

Quick Guide

this device. Otherwise, the service life of the image sensor may be shortened.

- If this device is installed in places where thunder and lightning frequently occur, ground the device nearby to discharge high energy such as thunder strikes in order to prevent device damage.

CAUTION

- Avoid heavy loads, intensive shakes, and soaking to prevent damages during transportation and storage. The warranty does not cover any device damage that is caused during secondary packaging and transportation after the original packaging is taken apart.
- Protect this device from fall-down and intensive strikes, keep the device away from magnetic field interference, and do not install the device in places with shaking surfaces or under shocks.
- Clean the device with a soft dry cloth. For stubborn dirt, dip the cloth into slight neutral cleanser, gently wipe the dirt with the cloth, and then dry the device.
- Do not jam the ventilation opening. Follow the installation instructions provided in this document when installing the device.
- Keep the device away from heat sources such as radiators, electric heaters, or other heat equipment.
- Keep the device away from moist, dusty, extremely hot or cold places, or places with strong electric radiation.
- If the device is installed outdoors, take insect- and moisture-proof measures to avoid circuit board corrosion that can affect monitoring.
- Remove the power plug if the device is idle for a long time.
- Before unpacking, check whether the fragile sticker is damaged. If the fragile sticker is damaged, contact customer services or sales personnel. The manufacturer shall not be held responsible for any artificial damage of the fragile sticker.

Precautions

Fully understand this document before using this device, and strictly observe rules in this document when using this device. If you install this device in public places, provide the tip "You have entered the area of electronic surveillance" in an eye-catching place. Failure to correctly use electrical products may cause fire and severe injuries.

	WARNING It alerts you to moderate dangers which, if not avoided, may cause minor or moderate injuries.
	CAUTION It alerts you to risks. Neglect of these risks may cause device damage, data loss, device performance deterioration, or unpredictable results.
	NOTE It provides additional information.

WARNING

- Strictly observe installation requirements when installing the device. The manufacturer shall not be held responsible for device damage caused by users' non-conformance to these requirements.
- Strictly conform to local electrical safety standards and use power adapters that are marked with the LPS standard when installing and using this device. Otherwise, this device may be damaged.
- Use accessories delivered with this device. The voltage must meet input voltage requirements for this device.
- If this device is installed in places with unsteady voltage, ground this device to discharge high energy such as electrical surges in order to prevent the power supply from burning out.
- When this device is in use, ensure that no water or any liquid flows into the device. If water or liquid unexpectedly flows into the device, immediately power off the device and disconnect all cables (such as power cables and network cables) from this device.
- Do not focus strong light (such as lighted bulbs or sunlight) on

Special Announcement

- All complete products sold by the manufacturer are delivered along with nameplates, quick setup guide and accessories after strict inspection. The manufacturer shall not be held responsible for counterfeit products.
- The manufacturer will update this manual according to product function enhancement or changes and regularly update the software and hardware described in this manual. Update information will be added to new versions of this manual without prior notice.
- This manual may contain misprints, technology information that is not accurate enough, or product function and operation description that is slightly inconsistent with the actual product, the final interpretation of company is as a standard.
- This manual is only for reference and does not ensure that the information is totally consistent with the actual product. For consistency, see the actual product.

NOTE

For more information, please refer to website.

1 Open Package Examination

Open the package, check the appearance of product for no obvious damage, and confirm the item list for table 1-1 is consistent.

Table 1-1 Packing list

Component	Quantity	Remark
Eyeball Network Camera	1	
Quick Setup Guide	1	
Accessory package	1	
Location sticker	1	

2 Device Structure

2.1 Device Ports

NOTE

Different devices may have different interfaces, multi-head cables, and fill lights, please refer to the actual product.

Figure 2-1 Hardware interfaces

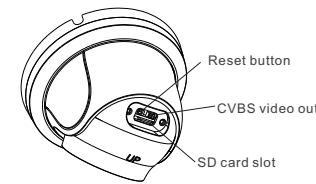

Table 2-1 Hardware interfaces description

ID	Port Name	Description
1	SD card slot	Install a SD card. NOTE <ul style="list-style-type: none"> Before installing a SD card, make sure the card not in write protection state. Before removing the SD card, make sure the card not in write protection state. Otherwise, the data may be lost ,or the SD card may be damaged.
2	CVBS video out	Output an analog video signal. You can connect the camera to a TV monitor through this interface to view the analog video.
3	Reset button	Long press the reset button for 5 seconds to restore the original settings.

Fill light settings

Camera's fill light has four modes, they are intelligent dual light (current fill light will switch to warm light after an alarm is triggered, and will switch back to the original fill light for 30s after the alert is released.), warm light, infrared lamp and none (Close the fill light and the color of image will stay in previous mode).

The different cameras can be set different fill light modes, please set fill light modes according to the actual scene.

- Day mode:** It can be used in the scene with sufficient ambient light for 24 hours, do not turn on the fill light, and the image is in color.
- Night mode:** It can be used in the scene where there is insufficient ambient light for 24 hours, turn on the fill light (it can be selected according to the four modes of the fill light).
- Auto mode:** Automatically switch the fill light mode according to the luminance of the environment.
- Timing mode:** Set the start and end time of the day, this time period is day mode for camera.

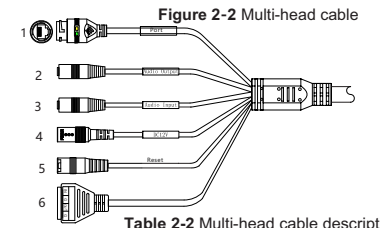

Table 2-2 Multi-head cable description

ID	Core	Description	Remark
1	Network access port	Connects to a standard Ethernet cable or PoE . The green light is on, the network connection is normal; The yellow light flashes when the data is transmitted. Some models maybe not have the lights, please refer to actual product.	Support PoE supply.
2	Audio output	Connects to an external audio device such as a speaker.	Applied for camera with audio function
3	Audio input port	Receives an analog audio signal from devices such as a sound pickup device.	
4	Reset button	Long press the reset button 5 seconds to restore the original settings.	
5	Power supply (DC 12V)	Connects to a 12V direct current (DC) power supply.	
6	G	Alarm output COM	Applied for alarm function
	OUT	Alarm output	
	G	Alarm input COM	
	IN	Alarm input	

2.2 Camera Dimensions

NOTE

Different devices may have different dimensions, please refer to the actual product.

Figure 2-3 Dimensions Unit: mm

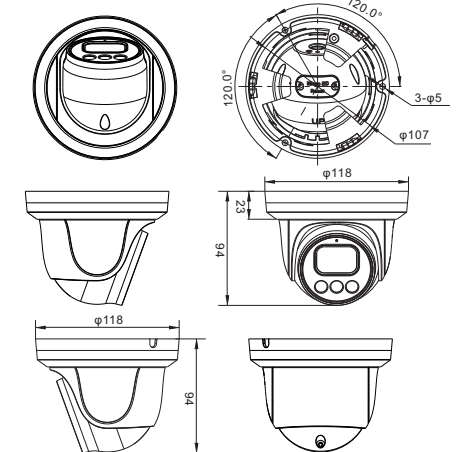

3 Device Installation

Installation Steps:

Step 1 Open the package, take out the camera, and disassemble camera's decorate cover, as shown in figure 3-1.

Figure 3-1 Disassemble camera

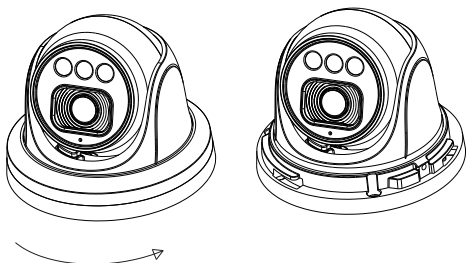

Step 2 Stick the installation location sticker on the ceiling or wall, drill three holes following the marks on the sticker. Push the swell plastic buttons into the holes, as shown in figure 3-2.

Step 3 Correspond the camera to swell plastic button, fix it to the ceiling (or wall) by using self-tapping screws.

Figure 3-2 Camera installation

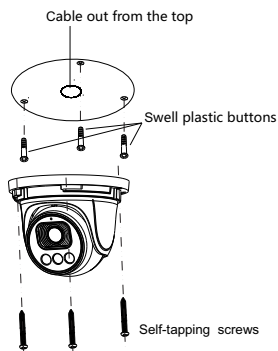

NOTE

You can route cables from the top or from aside. If you use the top routing method, drill a hole in the installation surface first, as shown in figure 3-2. If you use the aside routing method, please cut the compression ring outlet, and route the multi-head cable out from the side gap at the bottom of the camera.

Step 4 Connected the multi-connector cable, the camera is connected to screen to adjust monitoring perspective, then tighten the decorate cover, as shown in figure 3-3.

Figure 3-3 Finish installation

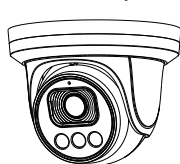

NOTE

The camera's monitoring angle can be adjusted by three-axis rotation: horizontal rotation, up and down rotation, axial rotation of the lens, adjust the direction of the camera and aim the lens at the target.

- 1 The hemisphere can rotate up and down range of 0 to 80°;
- 2 the hemisphere can rotate left and right range of 0 to 360°;
- 3 The ball lining can rotate 360° left and right.

4 Quick Configuration(e.g IE)

4.1 Login

Open the Internet Explorer, enter the IP address of IP camera (DHCP is on by default) in the address box, and press Enter. The login page is displayed, as shown in figure 4-1.

Figure 4-1 Login



NOTE

- There is no default password for the camera. User needs to create a new password when login for the first time. Shown in figure 4-2

Figure 4-2 Create password

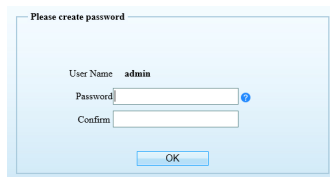

4.2 Modify IP address

Choose **Configuration > Device > Local Network**, the **Local Network** page is displayed. Input the IP address in the IP Address box and click **Apply** as shown in figure 4-3.

After the IP address is set successfully, please use the new IP address to login the Web interface.

Figure 4-3 Local Network

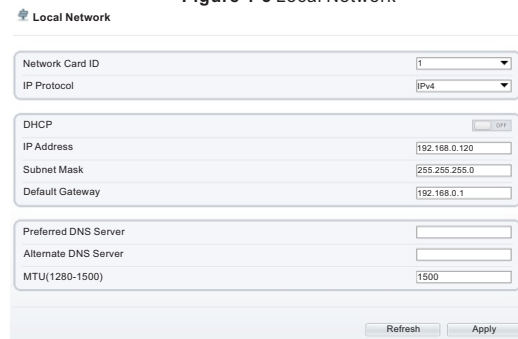

4.3 Browsing Video

To ensure the real-time video can be played properly, you must perform the following operation when you login the web for the first time:

Security > Trusted sites > Sites, in the display dialog box, click **Add**, as shown in figure 4-4.

Figure 4-4 Adding a trusted site

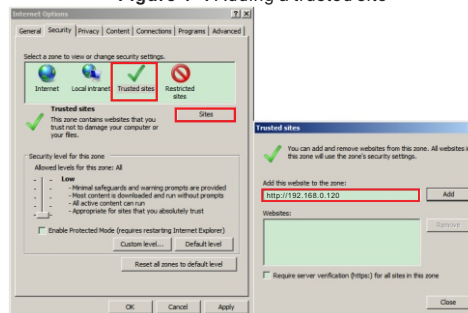

Step 2 In the Internet Explorer, choose **Tool > Internet Options > Security > Customer level**, and set **Download unsigned ActiveX control and initialize and script ActiveX controls not marked as safe for scripting under ActiveX controls and plug-ins to enable**, as shown in figure 4-5.

Figure 4-5 Configuring ActiveX control and plug-in

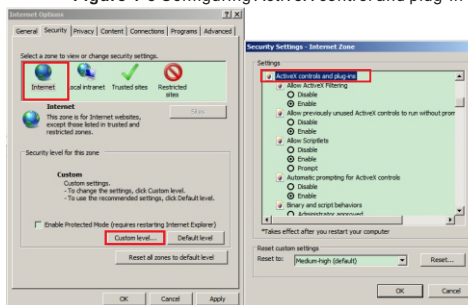

Step 3 Download and install the player control as prompted.

NOTE

If the repair tips displayed when installing the control, please ignore the prompt, and continue the installation, close the Web page during installing. Then login the page again.

To browse a real-time video, login the device and click **Live Video**. The Live Video page is displayed, as shown in figure 4-6.

Figure 4-6 Live Video

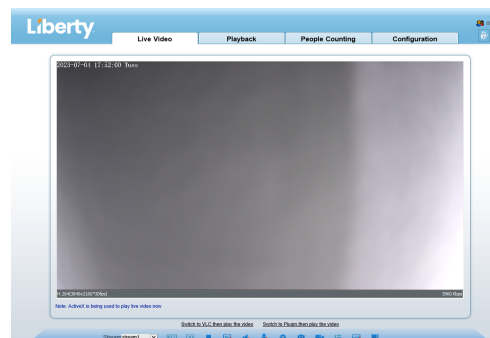

4.4 Intelligent Analysis

At "Configuration > Intelligent Analysis" interface, user can set the parameters of Perimeter, Single Virtual Fence, Double Virtual Fence, as shown in figure 4-7.

Figure 4-7 Intelligent Analysis

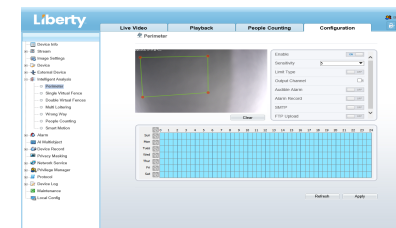

4.5 Alarm Configuration

NOTE

Partial camera do not support alarm, this section do not apply.

Alarm input and Alarm output connection:

Step1 Connect alarm input device to Alarm IN0 and Alarm COM0 of multi-head cable.

Step2 Connect alarm output device to Alarm OUT1 and Alarm COM1 of multi-head cable, alarm output interface can connect to normal open device only.

Step3 Log in Web, Choose **Configuration > Alarm > Alarm output**, set the parameters as shown in figure 4-8.

Step4 Choose **Configuration > Alarm > I/O Alarm Linkage**, enable the I/O Alarm and set the parameters of Schedule Setting.

Figure 4-8 Alarm

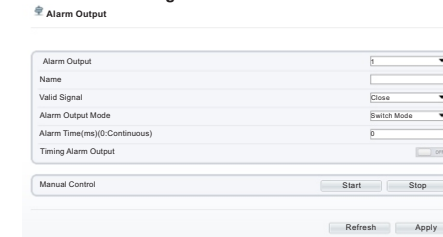

Supplier's Declaration of Conformity

Supplier's Declaration of Conformity

47 CFR § 2.1077 Compliance Information Unique Identifier:
L3IP4TS L3IP4TS4 L3IP4TFCS L3IP8TS L3IP8TS4

Responsible Party – U.S. Contact Information: Liberty Wire & Cable, Inc.
1490 Garden of the Gods Rd, Ste F Colorado Springs, CO 80907 855.388.7422

Warranty: The manufacturer warrants this product to be free from defects in workmanship and materials, under normal use and conditions, for a period of three (3) years from the original invoice date.



- If this device is installed in places where thunder and lightning frequently occur, ground the device nearby to discharge high energy such as thunder strikes in order to prevent device damage.

CAUTION

- Avoid heavy loads, intensive shakes, and soaking to prevent damages during transportation and storage. The warranty does not cover any device damage that is caused during secondary packaging and transportation after the original packaging is taken apart.
- Protect this device from fall-down and intensive strikes, keep the device away from magnetic field interference, and do not install the device in places with shaking surfaces or under shocks.
- Clean the device with a soft dry cloth. For stubborn dirt, dip the cloth into slight neutral cleanser, gently wipe the dirt with the cloth, and then dry the device.
- Do not jam the ventilation opening. Follow the installation instructions provided in this document when installing the device.
- Keep the device away from heat sources such as radiators, electric heaters, or other heat equipment.
- Keep the device away from moist, dusty, extremely hot or cold places.
- If the device is installed outdoors, take insect- and moisture-proof measures to avoid circuit board corrosion that can affect monitoring.
- Remove the power plug if the device is idle for a long time.

L3NVR4POE L3NVR4POE2T

Quick Guide

Precautions

Fully understand this document before using this device, and strictly observe rules in this document when using this device. If you install this device in public places, provide the tip "You have entered the area of electronic surveillance" in an eye-catching place. Failure to correctly use electrical products may cause fire and severe injuries.

WARNING	It alerts you to moderate dangers which, if not avoided, may cause minor or moderate injuries.
CAUTION	It alerts you about risks. Neglect of these risks may cause device damage, data loss, device performance deterioration, or unpredictable results.
NOTE	It provides additional information.

- **WARNING**
Strictly observe installation requirements when installing the device. The manufacturer shall not be held responsible for device damage caused by users' non-conformance to these requirements.

- Strictly conform to local electrical safety standards and use power adapters that are marked with the LPS standard when installing and using this device. Otherwise, this device may be damaged.

- Use accessories delivered with this device. The voltage must meet input voltage requirements for this device.
- If this device is installed in places with unsteady voltage, ground this device to discharge high energy such as electrical surges in order to prevent the power supply from burning out.

- When this device is in use, ensure that no water or any liquid flows into the device. If water or liquid unexpectedly flows into the device, immediately power off the device and disconnect all cables (such as power cables and network cables) from this device.

Special Announcement

- All complete products sold by the manufacturer are delivered along with nameplates, quick setup guide and accessories after strict inspection. The manufacturer shall not be held responsible for counterfeit products.

- The manufacturer will update this manual according to product function enhancement or changes and regularly update the software and hardware described in this manual. Update information will be added to new versions of this manual without prior notice.

- This manual may contain misprints, technology information that is not accurate enough, or product function and operation description that is slightly inconsistent with the actual product, the final interpretation of company is as a standard.

- This manual is only for reference and does not ensure that the information is totally consistent with the actual product. For consistency, see the actual product.

NOTE
For more information, please refer to website.

Supplier's Declaration of Conformity

Supplier's Declaration of Conformity
47 CFR § 2.1077 Compliance Information Unique Identifier: L3NVR4POE

Responsible Party – U.S. Contact Information: Liberty Wire & Cable, Inc.
1490 Garden of the Gods Rd, Ste F Colorado Springs, CO 80907 855.388.7422

Warranty: The manufacturer warrants this product to be free from defects in workmanship and materials, under normal use and conditions, for a period of three (3) years from the original invoice date.

1 Open Package Examination

Open the package, check the appearance of product for no obvious damage, and confirm the item list for table 1-1 is consistent.

Table 1-1 Packing list

Component	Quantity	Remark
Network video recording	1	
Quick Setup Guide	1	
Mouse	1	
Power adapter	1	
Power cord	1	
Phillips head screw	6	

Figure 2-1 Dimensions (Unit:mm)

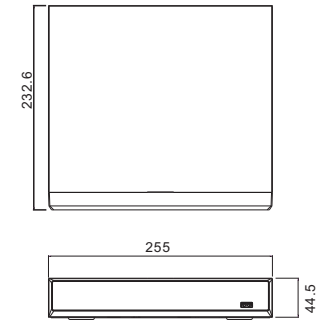

2 Device Structure

2.1 Device Ports

NOTE

Different device may have different ports and multi-head cable, please refer to the actual product.

Front panel description of device refer to table 2-1.

Table 2-1 Front panel description

Port Name	Description
PWR Indicator	When the NVR is operating, the PWR indicator is steady on. When the NVR is shut down, the PWR indicator is turned off.
HDD Indicator	Hard disk status indicator This indicator flashes when data is transmitted.
POE Indicator	POE network status indicator This indicator flashes when data is transmitted.
KB/MOUSE	Supports connection to an USB mouse or keyboard
BACKUP	Supports connection to an USB flash drive or USB removable hard disk.

Rear panel description of device, please refer to table 2-2.

Table 2-2 Rear panel description

Name	Description
PoE Port	PoE network interfaces
LAN	RJ45 10 /100/1000 Mbps adaptive. Ethernet interface
AUDIO OUT/ AUDIO IN	Audio output / Audio input
VGA	Video output interface
HDMI	
Alarm I/O	Alarm input/Alarm output
DC48V	Connected to an external power adapter
	Power switch
USB	USB 2.0 port

2.2 Device Dimensions

NOTE

Different device may have different dimensions, please refer to the actual product.

3 Device Installation

Take the following steps to install hard disk:

Step 1 Remove the screws for fixing the cover and take down the cover.

Step 2 Take out the screws and mount two of them to the screw holes, as shown in figure 3-1.

Figure 3-1 Installing the hard disk screws

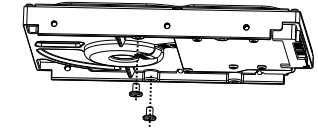

NOTE

Just screw the screws about 1 to 2 turns, instead of tightening.

Step 3 Route the screws through the cucurbit holes on the base, push the hard disk to the appropriate position, as shown in figure 3-2.

Figure3-2 Installing hard disk

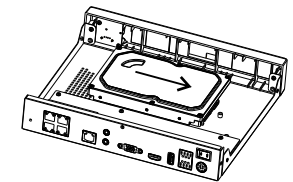

Step 4 Turn the device over, and mount another two screws to the holes as shown in figure 3-3. Then fasten all screws.

Figure3-3 Fixing hard disk

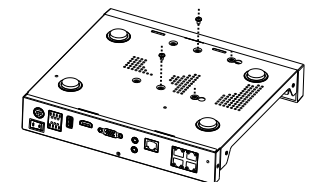

Step 5 Insert the hard disk data cable and power cable, then put on the upper cover and fasten the fixing screws.

4 Device Operation

4.1 Startup

Before starting NVR, ensure that the NVR is connected to a power supply properly and a monitor is connected to the HDMI or VGA interface of the NVR correctly. After starting the NVR, there is a login window located in the center, as shown in figure 4-1.

CAUTION In some environments, if the power supply is abnormal, the NVR may not work properly. In severe cases, the NVR may be damaged. In these environments, you are advised to use regulated power supply.

Figure 4-1 Activation interface

Figure 4-2 Login interface

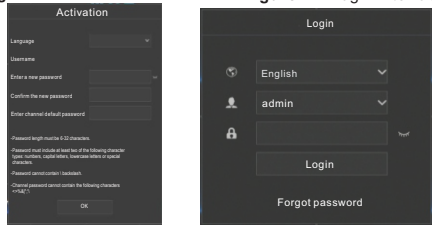

NOTE User needs to create a new password to activate the device, when logging in at first time. User can also set pattern unlock to quickly login. Set security questions to recovery password. Change the language at logging in interface.

4.2 Topology of the NVR

NVR with POE ports can access IP cameras immediately when plug IP cameras into NVR's POE ports. Then the NVR will assign an IP address for each camera automatically. The topology refer to figure 4-3.

Figure 4-3 Topology of the NVR

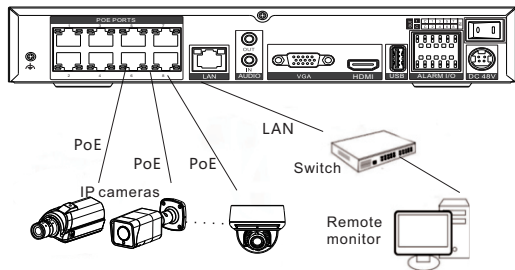

4.3 Power off

Enter the path **Main Menu >System > Maintenance > Shutdown** to power off the NVR.

NOTE

Before replacing the hard disk, the power must be turned off.

5 Quick Configuration

Plug in power to access the NVR user page, the wizard window would show at first time, user can configure quickly or close immediately. The details of configure please refer to main menu. Use mouse to right-click any where of the main interface to access the main menu. Main menu comprises Channel, Record, Alarm, Network and System settings, as shown in figure 5-1.

5.1 Channel

Channel settings contain Camera, Encode, Sensor Setting, OSD, Privacy Zone, ROI, Microphone.

Camera: user can add cameras automatically by clicking **Click to Add**, and add manually by clicking **add**. Tick cameras then click **Delete** to delete cameras. User can batch update software.

Figure 5-1 Main menu



- **Sensor Setting:** set the sensor parameter of channels' cameras.
- **OSD /Privacy Zone/ROI:** set on live video screen.
- **Microphone:** adjust and set the microphone of channels.
- All these settings can be copied to other channels by clicking **copy** button.

5.2 Record

Record settings contain Record Schedule, Disk, Storage, Disk Calculation, SMART and Disk Detection. Set record schedule and storage strategic. user can calculate the disk using time at Disk calculation interface.

Enter SMART interface to view the state of disks. Disk detection can detect the disks.

5.3 Alarm

Alarm settings contain General, Motion detection, Video loss, Intelligent analysis, Alarm in, Abnormal alarm, Alarm out as shown in figure 5-2

Figure 5-2 Alarm

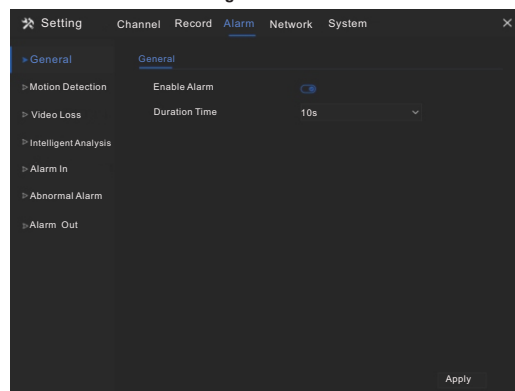

General : enable or disable alarm and set duration time of alarm.

• **Motion Detection :** enable this function, if detection the motion actions, it will alarm.

1.Event actions: contain buzzer, alarm out, push message to App, pop-up message to monitor, send E-mail and post recording (after enabling, choose the recording time from drop list.)

2.Area: set motion detection area. Press left button and drag the cursor to add a detection area ,and double-click an area to delete it.

3.Schedule: set schedule to enable or disable motion detection alarm. There are three methods to set, click the double arrows button to choose all day .The second, click and drag the cursor to select periods. The third, click one by one.

• **Video Loss , Intelligent Analysis** are same settings as motion detection.

• **Alarm In:** settings for I/O alarming. **Abnormal Alarm** can tick disk error, IP conflict, network disconnected.

5.4 Network

Network settings contain Network, 802.1X, DDNS, E-mail, Port Mapping, P2P, IP Filter and SNMP as shown in figure 5-3.

Figure 5-3 Network

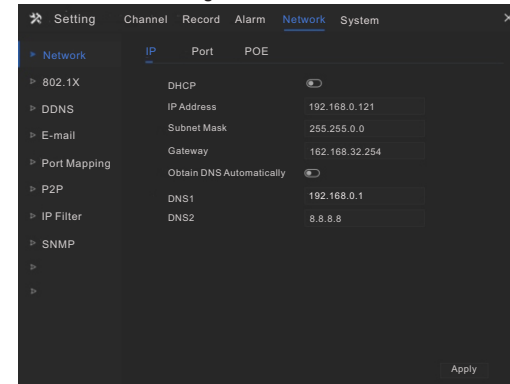

- **Network,802.1X, DDNS, and SNMP** interface to set network parameters.
- **E-mail:** set E-mails for sending and receiving alarm messages and password retrieval message.
- **Port Mapping:** set the ports for remote accessing.
- **P2P:** add NVR into device list of App by accessing the QR code.
- **IP Filter:** settings for creating black list or white list.

5.5 System

System settings contain Information, General, User, Security Center, Auto Sequence, Logs, Maintenance and Auto Restart, as shown in Figure 5-4.

Figure 5-4 System

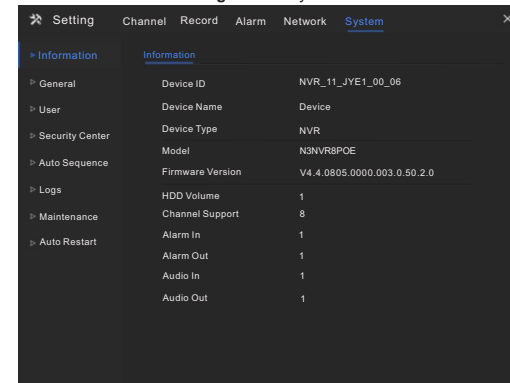

- **General:** include system, date and time, time zone, DST.
- **User:** add user and set advance setting(auto login, password double authentication, boot wizard).
- **Security Center:** modify the password, pattern unlock, secure Email, Secure question.
- **Auto Sequence:** settings for sequencing view of the channels.
- **Logs:** shows operating and alarm log, user can export logs if an USB disk is plugged in.
- **Maintenance:** include shutdown, reboot, exit system, reset, import configuration, export configuration and update.
- **Auto Restart:** enable this function to make device restart periodically.

5.6 Live Video

Live video page is showed after starting the NVR by default, as shown in figure 5-5.

Figure 5-5 Live video



6 Mobile Client

Search for "Liberty View" in App Store or Google Play to download and install the mobile client. Use the App to scan the QR code on the back board of NVR, or in P2P settings page in NVR user interface. Then input the password of the NVR to add the NVR into the device list of the App. User can manage the device though mobile client.

Figure 6-1 P2P

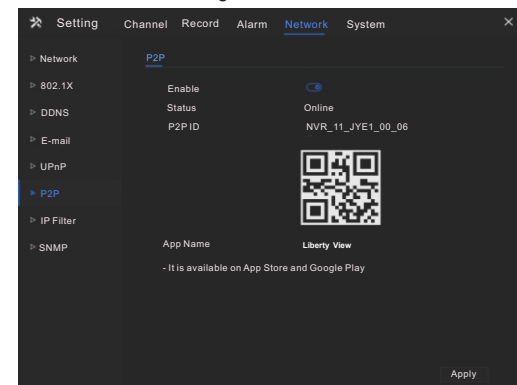

7 Web Accessing

The NVR also can be accessed in a Web browser. Open a web browser like IE and enter the IP address of device (DHCP is on by default) in the address box, and press **Enter**. The login page is displayed as shown in figure 7-1.

Figure 7-1 Login

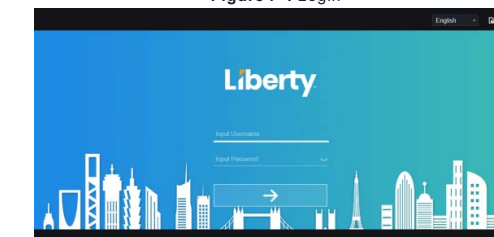

NOTE

The user name and password are same as the UI interface.



- If this device is installed in places where thunder and lightning frequently occur, ground the device nearby to discharge high energy such as thunder strikes in order to prevent device damage.

CAUTION

- Avoid heavy loads, intensive shakes, and soaking to prevent damages during transportation and storage. The warranty does not cover any device damage that is caused during secondary packaging and transportation after the original packaging is taken apart.
- Protect this device from fall-down and intensive strikes, keep the device away from magnetic field interference, and do not install the device in places with shaking surfaces or under shocks.

- Clean the device with a soft dry cloth. For stubborn dirt, dip the cloth into slight neutral cleanser, gently wipe the dirt with the cloth, and then dry the device.

- Do not jam the ventilation opening. Follow the installation instructions provided in this document when installing the device.

- Keep the device away from heat sources such as radiators, electric heaters, or other heat equipment.

- Keep the device away from moist, dusty, extremely hot or cold places.

- If the device is installed outdoors, take insect- and moisture-proof measures to avoid circuit board corrosion that can affect monitoring.

- Remove the power plug if the device is idle for a long time.

1 Open Package Examination

Open the package, check the appearance of product for no obvious damage, and confirm the item list for table 1-1 is consistent.

Table 1-1 Packing list

Component	Quantity	Remark
Network Video Recorder	1	
Quick Setup Guide	1	
Mouse	1	
Power adapter	1	Optional
Power cord	1	
Phillips head screw	12	
Terminal block	2	Optional

2 Device Structure

2.1 Device Ports

NOTE

Different device may have different ports and multi-head cable, please refer to the actual product.

Front panel description of device, please refer to table 2-1.

Table 2-1 Front panel description

Port Name	Description
PWR Indicator	When the NVR is operating, the PWR indicator is steady on. When the NVR is shut down, the PWR indicator is turned off.
HDD Indicator	Hard disk status indicator This indicator flashes when data is transmitted.
PoE Indicator	PoE network status indicator This indicator flashes when data is transmitted.
KB/MOUSE	Supports connection to a USB mouse or keyboard.
BACKUP	Supports connection to a USB flash drive or USB removable hard disk.

Rear panel description of device, please refer to table 2-2.

Table 2-2 Rear panel description

Name	Description
PoE Port	PoE network interfaces
LAN	RJ45 10 /100/1000 Mbps adaptive. Ethernet interface
AUDIO OUT/ AUDIO IN	Audio output / Audio input
VGA	Video output interface
HDMI	
Alarm I/O	Alarm input/Alarm output
	AC 110V -220V
	Power switch
USB	USB 2.0 port

2.2 Device Dimensions

NOTE

Different device may have different dimensions, please refer to the actual product.

Figure 2-1 Dimensions (Unit:mm)

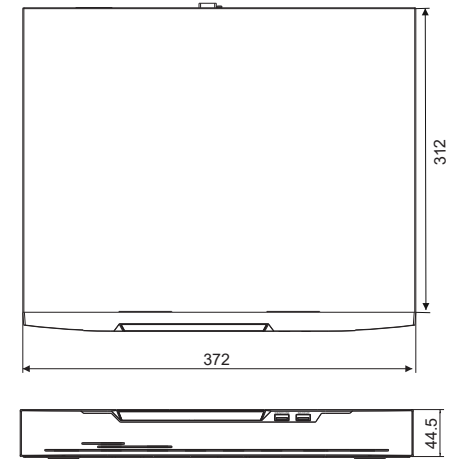

L3NVR8POE L3NVR8POE2T
L3NVR16POE L3NVR16POE2T L3NVR16POE4T

Quick Guide

Precautions

Fully understand this document before using this device, and strictly observe rules in this document when using this device. If you install this device in public places, provide the tip "You have entered the area of electronic surveillance" in an eye-catching place. Failure to correctly use electrical products may cause fire and severe injuries.

	WARNING It alerts you to moderate dangers which, if not avoided, may cause minor or moderate injuries.
	CAUTION It alerts you about risks. Neglect of these risks may cause device damage, data loss, device performance deterioration, or unpredictable results.
	NOTE It provides additional information.

- **WARNING** Strictly observe installation requirements when installing the device. The manufacturer shall not be held responsible for device damage caused by users' non-conformance to these requirements.

- Strictly conform to local electrical safety standards and use power adapters that are marked with the LPS standard when installing and using this device. Otherwise, this device may be damaged.

- Use accessories delivered with this device. The voltage must meet input voltage requirements for this device.
- If this device is installed in places with unsteady voltage, ground this device to discharge high energy such as electrical surges in order to prevent the power supply from burning out.

- When this device is in use, ensure that no water or any liquid flows into the device. If water or liquid unexpectedly flows into the device, immediately power off the device and disconnect all cables (such as power cables and network cables) from this device.

Special Announcement

- All complete products sold by the manufacturer are delivered along with nameplates, quick setup guide and accessories after strict inspection. The manufacturer shall not be held responsible for counterfeit products.

- The manufacturer will update this manual according to product function enhancement or changes and regularly update the software and hardware described in this manual. Update information will be added to new versions of this manual without prior notice.

- This manual may contain misprints, technology information that is not accurate enough, or product function and operation description that is slightly inconsistent with the actual product, the final interpretation of company is as a standard.

- This manual is only for reference and does not ensure that the information is totally consistent with the actual product. For consistency, see the actual product.

NOTE

For more information, please refer to website.

Supplier's Declaration of Conformity

Supplier's Declaration of Conformity
47 CFR § 2.1077 Compliance Information Unique Identifier:
L3NVR8POE, L3NVR16POE

Responsible Party – U.S. Contact Information: Liberty Wire & Cable, Inc.
1490 Garden of the Gods Rd, Ste F Colorado Springs, CO 80907 855.388.7422

Warranty: The manufacturer warrants this product to be free from defects in workmanship and materials, under normal use and conditions, for a period of three (3) years from the original invoice date.

3 Device Installation

The hard disk of the NVR must be provided by the user. Take the following steps to install hard disks:
Step 1 Remove the screws for fixing the cover and take down the cover.
Step 2 Take out the screws and mount two of them to the screw holes of hard disk, as shown in figure 3-1.

Figure 3-1 Installing the hard disk screws

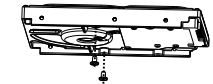

NOTE

- Just screw the screws about 1 to 2 turns instead to the end.

- Step 3 Route the screws through the gourd holes on the base, push the hard disk to the appropriate position on the left, as shown in figure 3-2.
- Step 4 Turn the device over, and mount other two screws to the holes, as shown in figure 3-3. Then fasten all the screws.

Figure 3-2 Installing hard disk Figure 3-3 Fixing hard disk

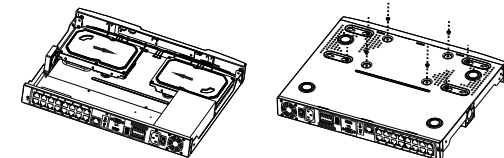

- Step 5 Install other hard disks following step 2, step 3 and step 4, and insert the hard disk data cable and power cable, then put on the upper cover and fasten the fixing screws.

4 Device Operation

4.1 Startup

Before starting NVR, ensure that the NVR is connected to a power supply properly and a monitor is connected to the HDMI or VGA interface of the NVR correctly. After starting the NVR, there is a login window located in the center, as shown in figure 4-1.

CAUTION In some environments, if the power supply is abnormal, the NVR may not work properly. In severe cases, the NVR may be damaged. In these environments, you are advised to use regulated power supply.

Figure 4-1 Activation interface

Figure 4-2 Login interface

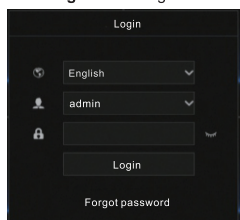
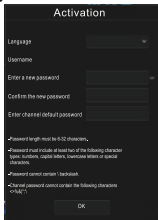

NOTE

User needs to create a new password to activate the device, when logging in at first time. User can also set pattern unlock to quickly login. Set security questions to recovery password. Change the language at logging in interface.

4.2 Topology of the NVR

NVR with POE ports can access IP cameras immediately when plug IP cameras into NVR's POE ports. Then the NVR will assign an IP address for each camera automatically. The topology refer to figure 4-3.

Figure 4-3 Topology of the NVR

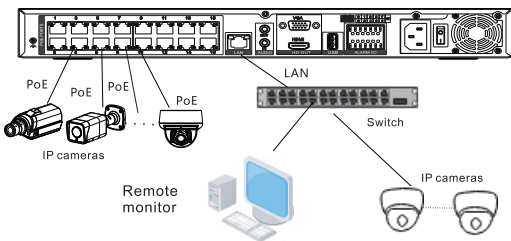

4.3 Power off

Enter the path **Main Menu > System > Maintenance > Shutdown** to power off the NVR.

NOTE

Before replacing the hard disk, the power must be turned off.

5 Quick Configuration

Plug in power to access the NVR user page, the wizard window would show at first time, user can configure quickly or close immediately. The details of configure please refer to main menu. Use mouse to right-click any where of the main interface to access the main menu. Main menu comprises Channel, Record, Alarm, Network and System settings, as shown in figure 5-1.

5.1 Channel

Channel settings contain Camera, Encode, Sensor Setting, OSD, Privacy Zone, ROI, Microphone, Human Thermal, Smart, Intelligent Tracking.

- Camera:** user can add cameras automatically by clicking **Click to Add**, and add manually by clicking **add**. Tick cameras then click **Delete** to delete cameras. User can batch update software.

Figure 5-1 Main menu

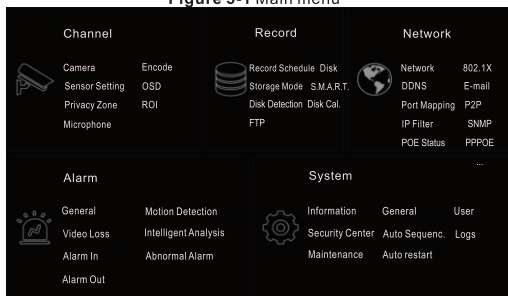

- Sensor Setting:** set the sensor parameter of channels' cameras.
- OSD/Privacy Zone/ROI:** set on live video screen.
- Microphone:** adjust and set the microphone of channels.
- All these settings can be copied to other channels by clicking **copy** button.

5.2 Record

Record settings contain Record Schedule, Disk, Storage, Disk Calculation, SMART and Disk Detection. Set record schedule and storage strategic. user can calculate the disk using time at Disk calculation interface.

Enter SMART interface to view the state of disks. Disk detection can detect the disks.

5.3 Alarm

Alarm settings contain General, Motion detection, Video loss, Intelligent analysis, Alarm in, Abnormal alarm, Alarm out as shown in figure 5-2

Figure 5-2 Alarm

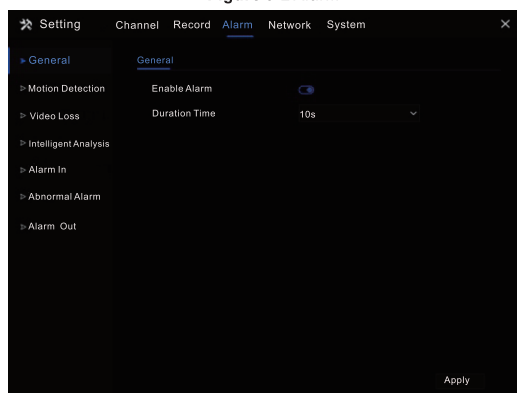

General: enable or disable alarm and set duration time of alarm.
Motion Detection: enable this function, if detection the motion actions, it will alarm.

- Event actions:** contain buzzer, alarm out, push message to App, pop-up message to monitor, send E-mail and post recording (after enabling, choose the recording time from drop list.)
- Area:** set motion detection area. Press left button and drag the cursor to add a detection area, and double-click an area to delete it.
- Schedule:** set schedule to enable or disable motion detection alarm. There are three methods to set, click the double arrows button to choose all day. The second, click and drag the cursor to select periods. The third, click one by one.
- Video Loss, Intelligent Analysis** are same settings as motion detection.
- Alarm In:** settings for I/O alarming. **Abnormal Alarm** can tick disk error, IP conflict, network disconnected.

5.4 Network

Network settings contain Network, 802.1X, DDNS, E-mail, Port Mapping, P2P, IP Filter and SNMP as shown in figure 5-3.

Figure 5-3 Network

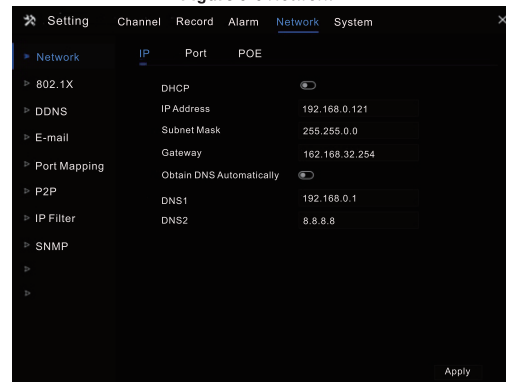

- Network, 802.1X, DDNS, and SNMP** interface to set network parameters.
- E-mail:** set E-mails for sending and receiving alarm messages and password retrieval message.
- Port Mapping:** set the ports for remote accessing.
- P2P:** add NVR into device list of App by accessing the QR code.
- IP Filter:** settings for creating black list or white list.

5.5 System

System settings contain Information, General, User, Security Center, Auto Sequence, Logs, Maintenance and Auto Restart, as shown in Figure 5-4.

Figure 5-4 System

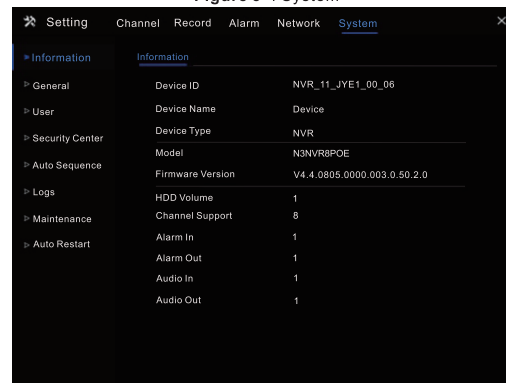

- General:** include system, date and time, time zone, DST.
- User:** add user and set advance setting (auto login, password double authentication, boot wizard).
- Security Center:** modify the password, pattern unlock, secure Email, Secure question.
- Auto Sequence:** settings for sequencing view of the channels.
- Logs:** shows operating and alarm log, user can export logs if an USB disk is plugged in.
- Maintenance:** include shutdown, reboot, exit system, reset, import configuration, export configuration and update.
- Auto Restart:** enable this function to make device restart periodically.

5.6 Live Video

Live video page is showed after starting the NVR by default, as shown in figure 5-5.

Figure 5-5 Live video

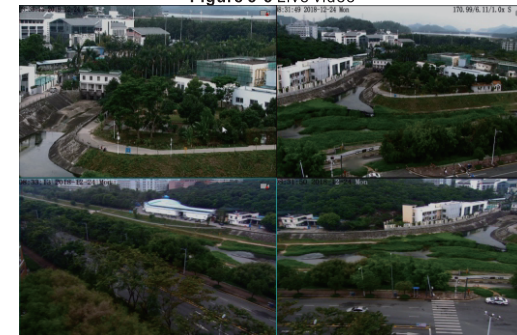

6 Mobile Client

Search for "**Liberty View**" in App Store or Google Play to download and install the mobile client. Use the App to scan the QR code on the back board of NVR, or in P2P settings page in NVR user interface. Then input the password of the NVR to add the NVR into the device list of the App. User can manage the device through mobile client.

Figure 6-1 P2P

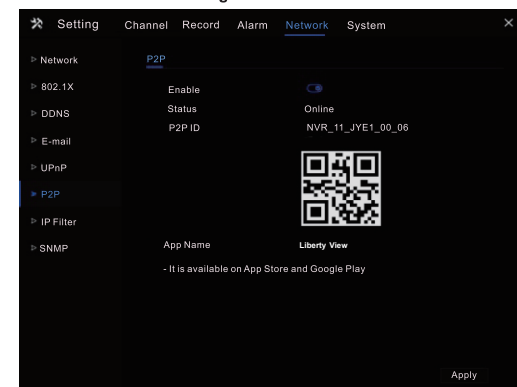

7 Web Accessing

The NVR also can be accessed in a Web browser. Open a web browser like IE and enter the IP address of device (DHCP is on by default) in the address box, and press **Enter**. The login page is displayed as shown in figure 7-1.

Figure 7-1 Login

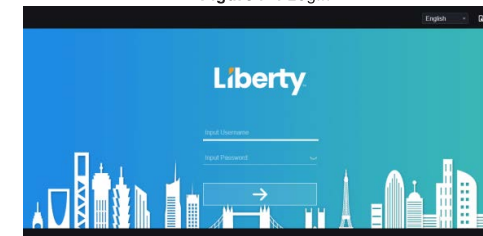

NOTE

The user name and password are same as the UI interface.