



LA5BFC60

Quick Guide

Precautions

Fully understand this document before using this device, and strictly observe rules in this document when using this device. If you install this device in public places, provide the tip "You have entered the area of electronic surveillance" in an eye-catching place. Failure to correctly use electrical products may cause fire and severe injuries.

WARNING	It alerts you to moderate dangers which, if not avoided, may cause minor or moderate injuries.
CAUTION	It alerts you to risks. Neglect of these risks may cause device damage, data loss, device performance deterioration, or unpredictable results.
NOTE	It provides additional information.

WARNING

- Strictly observe installation requirements when installing the device. The manufacturer shall not be held responsible for device damage caused by users' non-conformance to these requirements.
- Strictly conform to local electrical safety standards and use power adapters that are marked with the LPS standard when installing and using this device. Otherwise, this device may be damaged.
- Use accessories delivered with this device. The voltage must meet input voltage requirements for this device.
- If this device is installed in places with unsteady voltage, ground this device to discharge high energy such as electrical surges in order to prevent the power supply from burning out.
- When this device is in use, ensure that no water or any liquid flows into the device. If water or liquid unexpectedly flows into the device, immediately power off the device and disconnect all cables (such as power cables and network cables) from this device.
- Do not focus strong light (such as lighted bulbs or sunlight) on

this device. Otherwise, the service life of the image sensor may be shortened.

- If this device is installed in places where thunder and lightning frequently occur, ground the device nearby to discharge high energy such as thunder strikes in order to prevent device damage.

CAUTION

- Avoid heavy loads, intensive shakes, and soaking to prevent damages during transportation and storage. The warranty does not cover any device damage that is caused during secondary packaging and transportation after the original packaging is taken apart.
- Protect this device from fall-down and intensive strikes, keep the device away from magnetic field interference, and do not install the device in places with shaking surfaces or under shocks.
- Clean the device with a soft dry cloth. For stubborn dirt, dip the cloth into slight neutral cleanser, gently wipe the dirt with the cloth, and then dry the device.
- Do not jam the ventilation opening. Follow the installation instructions provided in this document when installing the device.
- Keep the device away from heat sources such as radiators, electric heaters, or other heat equipment.
- Keep the device away from moist, dusty, extremely hot or cold places, or places with strong electric radiation.
- If the device is installed outdoors, take insect- and moisture-proof measures to avoid circuit board corrosion that can affect monitoring.
- Remove the power plug if the device is idle for a long time.
- Before unpacking, check whether the fragile sticker is damaged. If the fragile sticker is damaged, contact customer services or sales personnel. The manufacturer shall not be held responsible for any artificial damage of the fragile sticker.
- Keep the device ventilation to avoid overheating.
- Do not install the device in extremely hot, cold, dusty, high salinity, high humidity, or corrosive environments; Forbid disassembling the device in these environments.
- If the equipment is disassembled for a long time, or the device is not installed properly after debugging, it will affect the sealing, cause the equipment to fog up and not work properly.

Special Announcement

- All complete products sold by the manufacturer are delivered along with nameplates, quick setup guide and accessories after strict inspection. The manufacturer shall not be held responsible for counterfeit products.
- The manufacturer will update this manual according to product function enhancement or changes and regularly update the software and hardware described in this manual. Update information will be added to new versions of this manual without prior notice.
- This manual may contain misprints, technology information that is not accurate enough, or product function and operation description that is slightly inconsistent with the actual product, the final interpretation of company is as a standard.
- This manual is only for reference and does not ensure that the information is totally consistent with the actual product. For consistency, see the actual product.

NOTE

For more information, please refer to website.

Supplier's Declaration of Conformity

Supplier's Declaration of Conformity
47 CFR § 2.1077 Compliance Information Unique Identifier: LA5BIR80

Responsible Party – U.S. Contact Information: Liberty Wire & Cable, Inc.
1490 Garden of the Gods Rd, Ste F Colorado Springs, CO 80907 855.388.7422

Warranty:
The manufacturer warrants this product to be free from defects in workmanship and materials, under normal use and conditions, for a period of three (3) years from the original invoice date.

1 Open Package Examination

Open the package, check the appearance of product for no obvious damage, and confirm the item list for table 1-1 is consistent.

Table 1-1 Packing list

Component	Quantity	Remark
Bullet HDVI Camera	1	
Quick Setup Guide	1	
Installation location sticker	1	
L wrench	1	
Black stainless self-tapping screw PA4.0×35mm	3	Alternative
Plastic anchor S8×30mm		
Black stainless self-tapping screw PA4.0×35mm	4	Alternative
Plastic anchor button S8×30mm		

2 Device Structure

2.1 Power and video cables

NOTE

Different devices may have different power cables; Please refer to the actual product.

Figure 2-1 Power and video cable

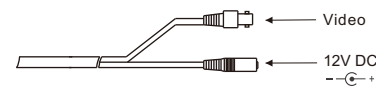

Connect the BNC connector of the power or video cable to a video signal cable and connect the other connector to a low-voltage power cable (12V DC or 24V AC, please refer to the label on the product box). After installing the camera, directly connect the video cable and power cable.

2.2 Function Keys

Users can call OSD main menus through multi function switch control keys, and check and set camera parameters, function keys is shown as figure 2-2.

Figure 2-2 Function keys

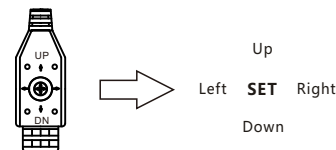

Operation description

SET key: It is used to enter OSD menus or select menu items when you press this key in the middle of the multi function switch.
UP/DOWN keys: The UP and DOWN keys are used to select menu items upwards and downwards by prodding the multi function switch upwards and downwards, the menu items rapidly roll upwards and downwards accordingly;
LEFT/RIGHT keys: The LEFT and RIGHT keys are used to select menu items horizontally or modify parameters by prodding the multi function switch towards the left or the right, the parameter values will rapidly decrease or increase.
 Press and hold the LEFT button for 5s to switch to AHD mode. Press and hold the RIGHT button for 5s to switch to TVI mode. Press and hold the UP button for 5s to switch to CVBS mode. Press and hold the DOWN button for 5s to switch to CVI mode.

NOTE

The detail operation of OSD please refer to *Camera OSD Operation Guide*.

2.3 Camera Dimensions

NOTE

Different devices may have different dimensions; Please refer to the actual product.

Figure 2-3 Fixed focus Dimensions 1 (Unit: mm)

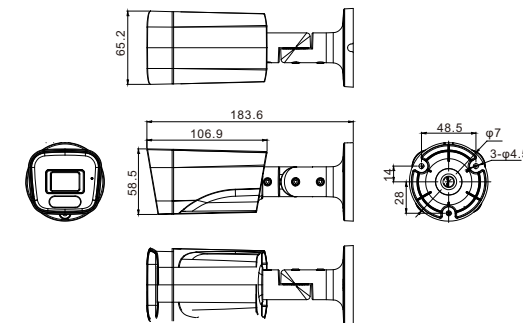

3 Device Installation

The Bullet HDVI Camera can be installed on the ceiling or wall. If the camera is installed on a concrete wall, install the plastic anchors before installing the bracket. If the camera is installed on a wooden wall, use self-tapping screws to install the bracket directly.

Installation Steps:

Step 1 Stick the Installation location sticker on the ceiling or wall, drill three (or four) holes based on the marks on the sticker. Drive the plastic anchors into the holes, as shown in figure 3-1.

Figure 3-1 Installing camera

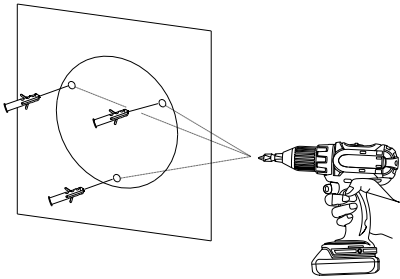

Step 2 Connect the power and video cable.

NOTE

You can route cables from the top or from the side. If you use the top routing method, drill a hole in the surface first. If you use the side routing method, please route the cable out from the side gap at the bottom of the camera.

Step 3 Install the camera on the ceiling or wall, and fix the screws as shown in figure 3-2.

Figure 3-2 Installing camera

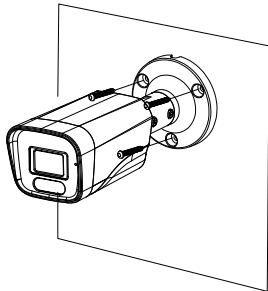

Step 4 Loosen the fixing screw (or locking ring) to adjust the

position and image so that the camera faces the monitored area, then tighten the fixing screw (the locking ring), as shown in figure 3-3.

Figure 3-3 Adjusting the monitoring direction

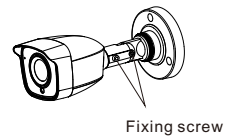
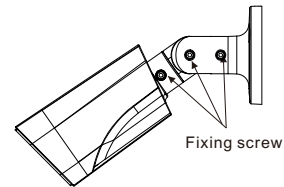
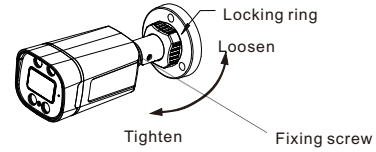
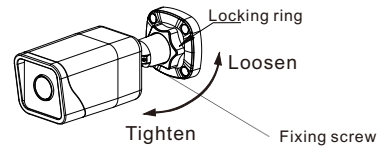

Step 5 Unscrew the fixing screw and open the lens cover, Use the focusing lever to adjust the lens and check images on the analog monitor until the captured images are clear. Then, lock the focusing lever, screw the cover and fasten the screw (This step is only applied for manually focusing lens products).

Figure 3-5 Adjusting the view angle and focal length

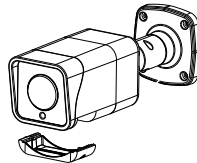

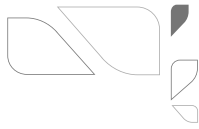

LA5BIR80

Quick Guide

Precautions

Fully read this document before using this device, and strictly observe rules in this document when using this device.

	It alerts you to moderate dangers which, if not avoided, may cause minor or moderate injuries.
	It alerts you to risks. Neglect of these risks may cause device damage, data loss, device performance deterioration, or unpredictable results.
	It provides additional information.

WARNING

Strictly observe installation requirements when installing the device. The manufacturer shall not be held responsible for device damage caused by users' non-conformance to these requirements.

Strictly conform to local electrical standards.

The voltage must meet input voltage requirements for this device.

If this device is installed in places with unsteady voltage, ground this device to discharge high energy such as electrical surges in order to prevent the power supply from burning out.

Do not expose internal components to water or moisture.

Do not focus strong light (such as lighted bulbs or sunlight) on this device. Otherwise, the service life of the image sensor may be shortened.

If this device is installed in places where thunder and lightning frequently occur, ground the device nearby to discharge high energy such as thunder strikes in order to prevent device damage.

CAUTION

- Avoid heavy loads, intensive shakes, and soaking to prevent damages during transportation and storage. The warranty does not cover any device damage that is caused during secondary packaging and transportation after the original packaging is taken apart.
- Protect this device from dropping, keep the device away from magnetic field interference, and do not install the device in places with unstable surfaces.
- Clean the device with a soft dry cloth. For stubborn dirt, dip the cloth into slight neutral cleanser, gently wipe the dirt with the cloth, and then dry the device.
- Keep the device away from heat sources such as radiators, electric heaters, or other heat equipment.
- Keep the device away from moist, dusty, extremely hot or cold places, or places with strong electric radiation.
- Remove the power plug if the device is idle for a long time.

Special Announcement

- The manufacturer will update this manual according to product function enhancement or changes. Update information will be added to new versions of this manual without prior notice.
- This manual is only for reference and does not ensure that the information is totally consistent with the actual product. For consistency, see the actual product.

NOTE

For more information, please refer to website: www.libertyonline.com

1 Open Package Examination

Open the package, check the appearance of product for no obvious damage, and confirm the item list for table 1-1 is consistent.

Table 1-1 Packing list

Component	Quantity	Remark
Bullet HDVI Camera	1	
Quick Setup Guide	1	
Installation location sticker	1	
L wrench	1	
Black stainless self-tapping screw PA4.0×30mm	4	
Plastic anchors φ5.6×29mm	4	

Supplier's Declaration of Conformity

Supplier's Declaration of Conformity
47 CFR § 2.1077 Compliance Information Unique Identifier: LA5BIR80

Responsible Party – U.S. Contact Information: Liberty Wire & Cable, Inc.
1490 Garden of the Gods Rd, Ste F Colorado Springs, CO 80907 855.388.7422

Warranty:
The manufacturer warrants this product to be free from defects in workmanship and materials, under normal use and conditions, for a period of three (3) years from the original invoice date.

2 Camera Cable Connection

2.1 Power and video cables

Insert power lead into power connector (insure proper voltage is supplied and observe polarity).

Insert video lead into BNC connector (push, then twist to lock BNC connector in place).

Figure 2-1 Power and video cable

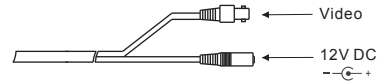

2.2 OSD Control: Use In-Line OSD control to select format: Press the Joystick button on the cable mounted OSD control to access the OSD menu.

- 960H Mode** : Push OSD UP for 5 seconds
- AHD Mode** : Push OSD LEFT for 5 seconds
- CVI Mode** : Push OSD DOWN for 5 seconds
- TVI Mode** : Push OSD RIGHT for 5 seconds

Figure 2-2 Function keys

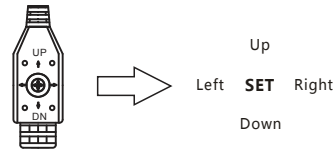

3 Camera Overview

3.1 Camera Dimensions

NOTE

Different device may have different dimensions, please refer to the actual product.

Figure 3-1 Dimensions (Unit: mm)

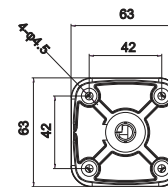
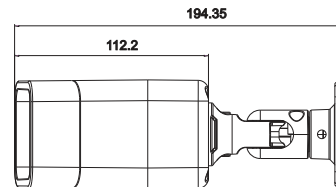

4 Device Installation

The Camera can be installed on the ceiling or wall. If the camera is installed on a concrete wall, install the plastic anchors before installing the bracket. If the camera is installed on a wooden wall, use self-tapping screws to install the bracket directly.

Figure 4-1 Installing camera

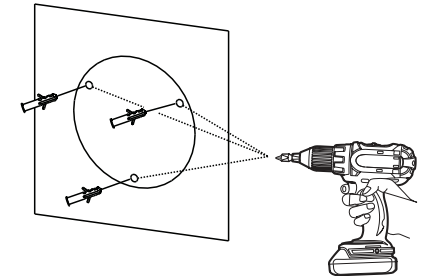

Installation Steps:

- Stick the Installation location sticker on the ceiling or wall. Drill three holes based on the marks on the sticker. Drive the swell plastic buttons into the holes.
- Connect the BNC cable.

NOTE

you can route cables from the top or from aside. If you use the top routing method, drill a hole in the surface first. If you use the aside routing method. When you route cables from aside, Please route the multi-head cable out from the side gap at the bottom of the camera.

- Install the camera on the ceiling or wall, and fix the screws as shown in figure 4-5.

Figure 4-5 Installing camera

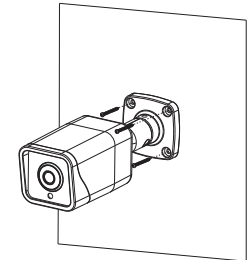

- Loosen the fixing screw and locking ring to adjust the position so that the camera faces the monitored area, then tighten the locking ring and the fixing screw, as shown in figure 4-6.

Figure 4-6 Adjusting the monitoring direction

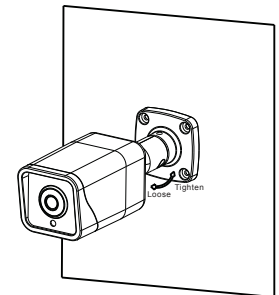

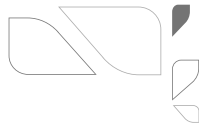

LA5PTZ33X

Quick Guide

Precautions

Fully understand this document before using this device, and strictly observe rules in this document when using this device. If you install this device in public places, provide the tip "You have entered the area of electronic surveillance" in an eye-catching place. Failure to correctly use electrical products may cause fire and severe injuries.

WARNING	It alerts you to moderate dangers which, if not avoided, may cause minor or moderate injuries.
CAUTION	It alerts you to risks. Neglect of these risks may cause device damage, data loss, device performance deterioration, or unpredictable results.
NOTE	It provides additional information.

WARNING

- Strictly observe installation requirements when installing the device. The manufacturer shall not be held responsible for device damage caused by users' non-conformance to these requirements.
- Strictly conform to local electrical safety standards and use power adapters that are marked with the LPS standard when installing and using this device. Otherwise, this device may be damaged.
- Use accessories delivered with this device. The voltage must meet input voltage requirements for this device.
- If this device is installed in places with unsteady voltage, ground this device to discharge high energy such as electrical surges in order to prevent the power supply from burning out.
- When this device is in use, ensure that no water or any liquid flows into the device. If water or liquid unexpectedly flows into the device, immediately power off the device and disconnect all cables (such as power cables and network cables) from this device.
- Do not focus strong light (such as lighted bulbs or sunlight) on

this device. Otherwise, the service life of the image sensor may be shortened.

- If this device is installed in places where thunder and lightning frequently occur, ground the device nearby to discharge high energy such as thunder strikes in order to prevent device damage.

CAUTION

- Avoid heavy loads, intensive shakes, and soaking to prevent damages during transportation and storage. The warranty does not cover any device damage that is caused during secondary packaging and transportation after the original packaging is taken apart.
- Protect this device from fall-down and intensive strikes, keep the device away from magnetic field interference, and do not install the device in places with shaking surfaces or under shocks.
- Clean the device with a soft dry cloth. For stubborn dirt, dip the cloth into slight neutral cleanser, gently wipe the dirt with the cloth, and then dry the device.
- Do not jam the ventilation opening. Follow the installation instructions provided in this document when installing the device.
- Keep the device away from heat sources such as radiators, electric heaters, or other heat equipment.
- Keep the device away from moist, dusty, extremely hot or cold places, or places with strong electric radiation.
- If the device is installed outdoors, take insect- and moisture-proof measures to avoid circuit board corrosion that can affect monitoring.
- Remove the power plug if the device is idle for a long time.
- Before unpacking, check whether the fragile sticker is damaged. If the fragile sticker is damaged, contact customer services or sales personnel. The manufacturer shall not be held responsible for any artificial damage of the fragile sticker.

Special Announcement

- All complete products sold by the manufacturer are delivered along with nameplates, quick setup guide and accessories after strict inspection. The manufacturer shall not be held responsible for counterfeit products.
- The manufacturer will update this manual according to product function enhancement or changes and regularly update the software and hardware described in this manual. Update information will be added to new versions of this manual without prior notice.
- This manual may contain misprints, technology information that is not accurate enough, or product function and operation description that is slightly inconsistent with the actual product, the final interpretation of company is as a standard.
- This manual is only for reference and does not ensure that the information is totally consistent with the actual product. For consistency, see the actual product.

NOTE

For more information, please refer to website.

1 Open Package Examination

Open the package, check the appearance of product for no obvious damage, and confirm the item list for table 1-1 is consistent.

Table 1-1 Packing list

Component	Quantity	Remark
High Speed Dome Camera	1	
Quick Setup Guide	1	
Instruction	1	
Power adapter	1	
Accessories package	1	
Wall mounting bracket	1	Default

2 Device Structure

2.1 Device Ports

NOTE

Different device may have different multi-head cable, please refer to the actual product.

Figure 2-1 Multi-head cable

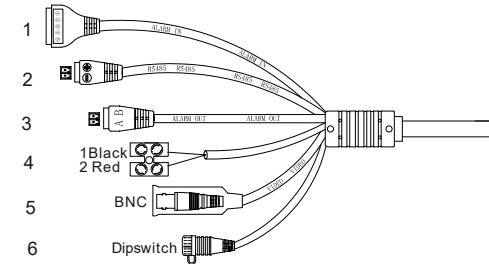

Table 2-1 Multi-head cable description

ID	Core	Description	Remark
1	Alarm IN	① Alarm in 1 ② Alarm in 2 ③ Alarm in 3 ④ Alarm in 4 ⑤ GND	
2	RS 485	Connects an external Pan Tilt Zoom (PTZ).	
3	Alarm OUT	A is alarm out . B is alarm out COM.	
4	Power port	Power supply, AC 24V. 1Red is AC24V + , 2 Black is AC24V - .	
5	BNC Video	Sends an analog video signal. You can connect the camera to a TV monitor through this port to view the analog video.	
6	Dipswitch	1 OFF 2 OFF AHD; 1 ON 2 OFF TVI; 1 OFF 2 ON CVI; 1ON 2ON CVBS	

NOTE

Dipswitch is the only option to change video format. RS485 and UTC control cannot be used to change video format.

2.2 Camera Dimensions

NOTE

Different device may have different dimensions, please refer to the actual product.

Figure 2-2 Dimensions (Unit: mm)

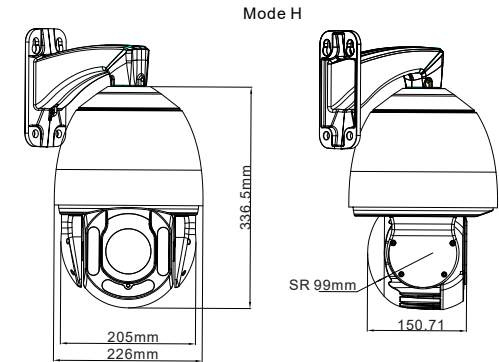

3 Device Installation

Installation Steps:

Step 1 Please make the mark based on bracket dimensions for drilling the hole. Drill four φ8 holes over 60 mm depth, and drive the swell plastic buttons into the holes.

Figure 3-1 Bracket dimensions(unit:mm)

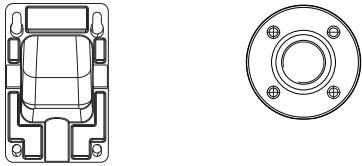

Step 2 Thread all cables through the cable hole on the side of the bracket, as shown in the figure 3-2.

Figure 3-2 Aligning the screw holes

Wall bracket Ceiling bracket

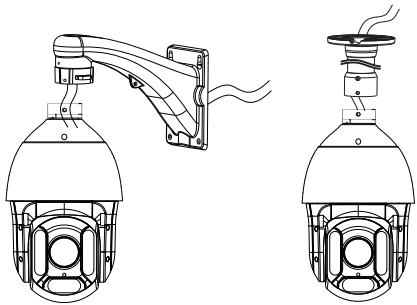

Step 3 Attach the high speed dome to the bracket, the tighten the three screws, as shown in figure 3-3.

Figure 3-3 Fixing the bracket and dome

Wall bracket Ceiling bracket

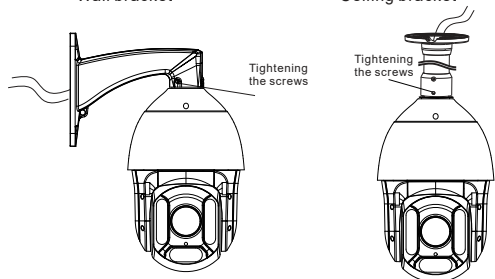

Step 4 Mount the high speed dome to the wall or ceiling and tighten the four screws on the bracket completely.

4 Camera Setting

4.1 PTZ settings

Step 1 After the high-speed camera is installed, connect the device to a digital video recorder (DVR) or analog screen.

Step 2. The live video is showing. At the screen, click the left mouse button and the icon appears, click PTZ icon, enter the PTZ and UTC settings interface, click the setting icon to enter the PTZ settings as shown in Figure 4-1.

Figure 4-1 Baud rate setting

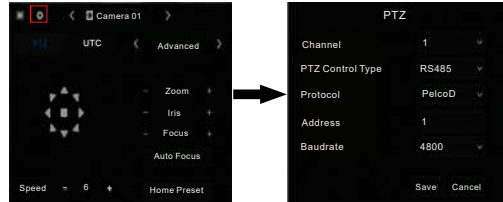

Step 3. Select the PTZ control protocol as RS485, the protocol to select PelcoD, and the baud rate to choose 4800.

Step 4. Click "Save" to save the PTZ settings.

NOTE

If the RS485 interface is on the DVR panel, the high-speed camera can be controlled by the RS485 protocol, otherwise it can only be directly controlled by the PTZ protocol.

4.2 PTZ keyboard

The PTZ keyboard can adjust the lens direction of the high-speed dome camera in multiple directions.

The right side menu allows you to select advanced setting, preset, scan, and tour.

Advanced settings: You can zoom, iris, focus, and auto focus on the high speed dome camera.

Preset position: Set the preset position, a total of 250 preset positions can be set. Two consecutive clicks the 9 or 95 preset positions can enter the main menu, as shown in Figure 4-2.

Figure 4-2 Main Menu

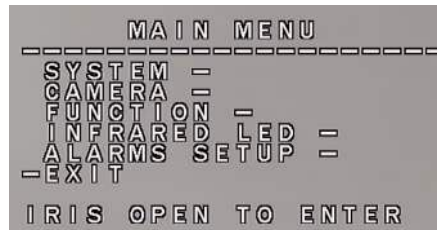

Scan: You can edit the set scan route.

Tour: You can set the tour according to the preset settings.

4.3 UTC

The UTC keyboard can adjust the main menu up and down, and confirm the save settings, as shown in Figure 4-3.

Left button to confirm the modification.

Right button to enter the next level menu and set the parameters.

The up and down button to move up and down to select a menu, and increase or decrease the value in the setting state.

Middle button to confirm and exit.

Figure 4-3 UTC menu



4.4 Main Menu

- System: user can view dome information, ID setting information, clock settings, set auto run, and default settings as shown in figure 4-4.
- Camera settings: user can set the focus zoom, lens initial, video format, default settings, etc., as shown in figure 4-5.
- Function settings: user can set preset, scan, tour, and pattern.
- The infrared LED setting is shown in Figure 4-6.
- The alarms setup: user can set the alarm parameter, as shown in Figure 4-7

Figure 4-4 SYSTEM

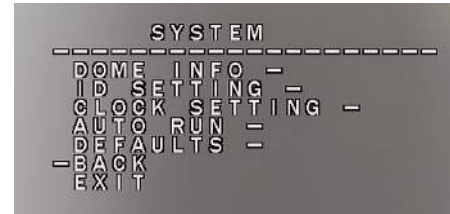

Figure 4-4 Camera setting

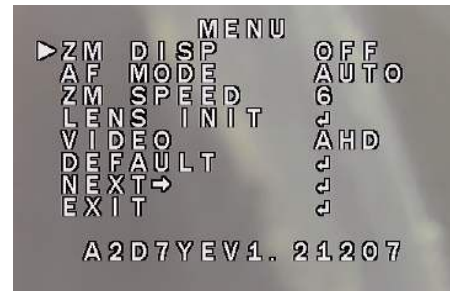

Figure 4-5 FUNCTION

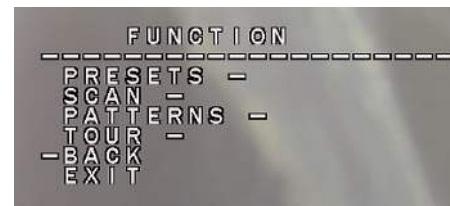

Figure 4-6 INFRARED LED

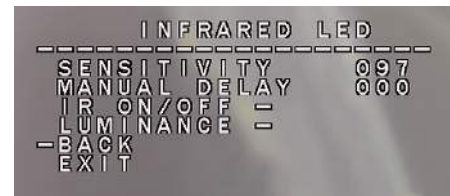

Figure 4-7 ALARMS SETUP



NOTE

Different device may have different showing pages, please refer to the actual product.

- "BACK" : Return to the previous menu.
- "EXIT" : Exit the main menu.
- "ON" : Open the setting.
- "OFF" : Turn off the setting.

5 Supplier's Declaration of Conformity

Supplier's Declaration of Conformity

47 CFR § 2.1077 Compliance Information Unique Identifier: LA5PTZ33X

Responsible Party – U.S. Contact Information: Liberty Wire & Cable, Inc.
1490 Garden of the Gods Rd, Ste F Colorado Springs, CO 80907 855.388.7422

Warranty:

The manufacturer warrants this product to be free from defects in workmanship and materials, under normal use and conditions, for a period of one (1) years from the original invoice date.



LA5TIR80

Quick Guide

Precautions

Fully read this document before using this device, and strictly observe rules in this document when using this device.

	It alerts you to moderate dangers which, if not avoided, may cause minor or moderate injuries.
	It alerts you to risks. Neglect of these risks may cause device damage, data loss, device performance deterioration, or unpredictable results.
	It provides additional information.

WARNING

Strictly observe installation requirements when installing the device. The manufacturer shall not be held responsible for device damage caused by users' non-conformance to these requirements.

Strictly conform to local electrical standards.

The voltage must meet input voltage requirements for this device.

If this device is installed in places with unsteady voltage, ground this device to discharge high energy such as electrical surges in order to prevent the power supply from burning out.

Do not expose internal components to water or moisture.

Do not focus strong light (such as lighted bulbs or sunlight) on this device. Otherwise, the service life of the image sensor may be shortened.

If this device is installed in places where thunder and lightning frequently occur, ground the device nearby to discharge high energy such as thunder strikes in order to prevent device damage.

CAUTION

Avoid heavy loads, intensive shakes, and soaking to prevent damages during transportation and storage. The warranty does not cover any device damage that is caused during secondary packaging and transportation after the original packaging is taken apart.

Protect this device from dropping, keep the device away from magnetic field interference, and do not install the device in places with unstable surfaces.

Clean the device with a soft dry cloth. For stubborn dirt, dip the cloth into slight neutral cleanser, gently wipe the dirt with the cloth, and then dry the device.

Keep the device away from heat sources such as radiators, electric heaters, or other heat equipment.

Keep the device away from moist, dusty, extremely hot or cold places, or places with strong electric radiation.

Remove the power plug if the device is idle for a long time.

Special Announcement

The manufacturer will update this manual according to product function enhancement or changes. Update information will be added to new versions of this manual without prior notice.

This manual is only for reference and does not ensure that the information is totally consistent with the actual product. For consistency, see the actual product.

NOTE

For more information, please refer to website: www.libertyonline.com

1 Open Package Examination

Open the package, check the appearance of product for no obvious damage, and confirm the item list for table 1-1 is consistent.

Table 1-1 Packing list

Component	Quantity	Remark
Bullet HDVI Camera	1	
Quick Setup Guide	1	
Installation location sticker	1	
Black stainless self-tapping screw PA4.0×35mm	4	
Swell plastic button S8×30mm	4	

Supplier's Declaration of Conformity

Supplier's Declaration of Conformity
47 CFR § 2.1077 Compliance Information Unique Identifier: LA5BIR80

Responsible Party – U.S. Contact Information: Liberty Wire & Cable, Inc.
1490 Garden of the Gods Rd, Ste F Colorado Springs, CO 80907 855.388.7422

Warranty:

The manufacturer warrants this product to be free from defects in workmanship and materials, under normal use and conditions, for a period of three (3) years from the original invoice date.

2 Device Structure

2.1 Power and video cables

NOTE

Different device may have different power cable, please refer to the actual product.

Figure 2-1 Power and video cable

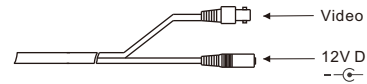

Connect the BNC connector of the power or video cable to a video signal cable and connect the other connector to a low-voltage power cable (12V DC or 24V AC). After installing the camera, directly connect the video cable and power cable.

2.2 Function Keys

Users can call OSD main menus through multi function switch control keys, and check and set camera parameters, function keys is shown as figure 2-2.

Figure 2-2 Function keys

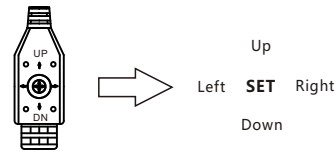

3 Camera Overview

3.1 Camera Dimensions

NOTE

Different device may have different dimensions, please refer to the actual product.

Figure 3-1 Dimensions (Unit: mm)

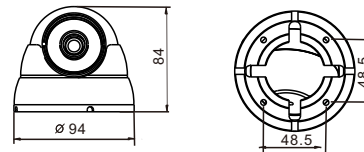

4 Device Installation

Installation Steps:

Step 1 Open a package, take out the camera and the accessories, unscrew the compression ring or use the screwdriver to loosen the screw, remove the compression ring, as shown in figure 3-1.

Figure 3-1 Removing compression ring

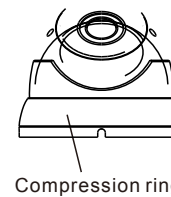

Step 2 Stick the Installation location sticker on the ceiling or wall, Drill three holes based on the marks on the sticker. Drive the swell plastic buttons into the holes.
Step 3 Fix the camera mounting base to the mounting surface, by use of self-tapping screws, as shown in figure 3-2.

Figure 3-2 Fixing the mounting base

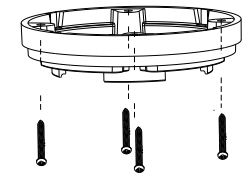

NOTE

you can route cables from the top or from aside. If you use the top routing method, drill a hole in the surface first. If you use the aside routing method. When you route cables from aside, please cut the compression ring outlet, as shown in figure 3-3, and route the cable out from the side gap at the bottom of the camera.

Figure 3-3 Cutting the compression ring outlet

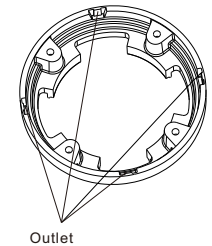

Step 4 Install the dome shell and the compression ring on the mounting base, adjust the position so that the camera faces the monitored area, then tighten the screw, as shown in figure 3-4.

Figure 3-4 Installing and adjusting camera

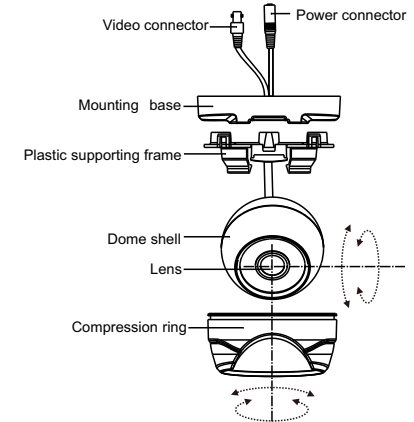



LA5TIR100 LA5TFC100

Quick Guide

Precautions

Fully read this document before using this device, and strictly observe rules in this document when using this device.

	It alerts you to moderate dangers which, if not avoided, may cause minor or moderate injuries.
	It alerts you to risks. Neglect of these risks may cause device damage, data loss, device performance deterioration, or unpredictable results.
	It provides additional information.

WARNING

Strictly observe installation requirements when installing the device. The manufacturer shall not be held responsible for device damage caused by users' non-conformance to these requirements.

Strictly conform to local electrical standards.

The voltage must meet input voltage requirements for this device.

If this device is installed in places with unsteady voltage, ground this device to discharge high energy such as electrical surges in order to prevent the power supply from burning out.

Do not expose internal components to water or moisture.

Do not focus strong light (such as lighted bulbs or sunlight) on this device. Otherwise, the service life of the image sensor may be shortened.

If this device is installed in places where thunder and lightning frequently occur, ground the device nearby to discharge high energy such as thunder strikes in order to prevent device damage.

CAUTION

Avoid heavy loads, intensive shakes, and soaking to prevent damages during transportation and storage. The warranty does not cover any device damage that is caused during secondary packaging and transportation after the original packaging is taken apart.

Protect this device from dropping, keep the device away from magnetic field interference, and do not install the device in places with unstable surfaces.

Clean the device with a soft dry cloth. For stubborn dirt, dip the cloth into slight neutral cleanser, gently wipe the dirt with the cloth, and then dry the device.

Keep the device away from heat sources such as radiators, electric heaters, or other heat equipment.

Keep the device away from moist, dusty, extremely hot or cold places, or places with strong electric radiation.

Remove the power plug if the device is idle for a long time.

Special Announcement

The manufacturer will update this manual according to product function enhancement or changes. Update information will be added to new versions of this manual without prior notice.

This manual is only for reference and does not ensure that the information is totally consistent with the actual product. For consistency, see the actual product.

NOTE

For more information, please refer to website: www.libertyonline.com

1 Open Package Examination

Open the package, check the appearance of product for no obvious damage, and confirm the item list for table 1-1 is consistent.

Table 1-1 Packing list

Component	Quantity	Remark
Bullet HDVI Camera	1	
Quick Setup Guide	1	
Installation location sticker	1	
L wrench	1	
Black stainless self-tapping screw PA4.0×30mm	3	
Plastic anchors φ5.6×29mm	3	

Supplier's Declaration of Conformity

Supplier's Declaration of Conformity
47 CFR § 2.1077 Compliance Information Unique Identifier: LA5BIR80

Responsible Party – U.S. Contact Information: Liberty Wire & Cable, Inc.
1490 Garden of the Gods Rd, Ste F Colorado Springs, CO 80907 855.388.7422

Warranty:

The manufacturer warrants this product to be free from defects in workmanship and materials, under normal use and conditions, for a period of three (3) years from the original invoice date.

2 Camera Cable Connection

2.1 Power and video cables

Insert power lead into power connector (insure proper voltage is supplied and observe polarity).

Insert video lead into BNC connector (push, then twist to lock BNC connector in place).

Figure 2-1 Power and video cable

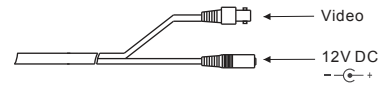

2.2 OSD Control: Use In-Line OSD control to select format:

Press the Joystick button on the cable mounted OSD control to access the OSD menu.

960H Mode : Push OSD UP for 5 seconds

AHD Mode : Push OSD LEFT for 5 seconds

CVI Mode : Push OSD DOWN for 5 seconds

TVI Mode : Push OSD RIGHT for 5 seconds

Figure 2-2 Function keys

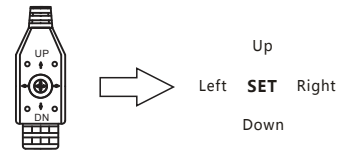

3 Camera Overview

3.1 Camera Dimensions

NOTE

Different device may have different dimensions, please refer to the actual product.

Figure 3-1 Dimensions (Unit: mm)

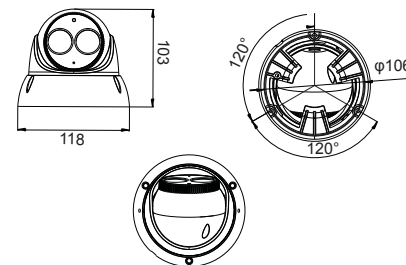

4 Device Installation

Step 1 Open a package, take out the camera and the accessories.
Step 2 Stick the Installation location sticker on the ceiling or wall, Drill three holes based on the marks on the sticker. Drive the swell plastic buttons into the holes, as shown in figure 4-1.

Figure 4-1 Drilling holes

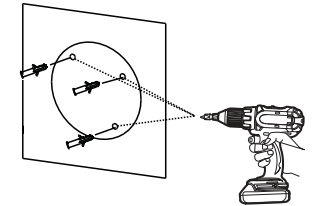

Step 3 Fix the camera to the mounting surface, by use of self-tapping screws, as shown in figure 3-2.

Figure 4-2 Fixing camera

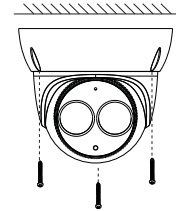

NOTE

you can route cables from the top or from aside. If you use the top routing method, drill a hole in the surface first. If you use the aside routing method. When you route cables from aside, Please route the multi-head cable out from the side gap at the bottom of the camera, as shown in figure 4-3.

Figure 4-3 Install camera

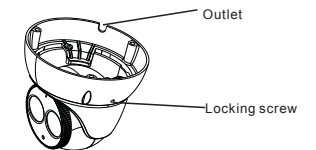

Step 4 Connect the BNC cable.

Step 5 Loosen the screws for two to three circles, install the dome shell and the compression ring on the mounting base, adjust the position so that the camera faces the monitored area, then tighten the screw, as shown in figure 4-4.

Figure 4-4 Adjusting camera

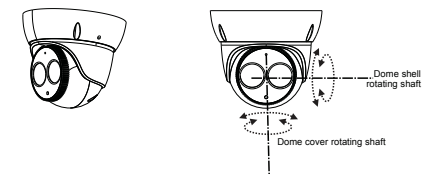



LA5VFBIR120

Quick Guide

Precautions

Fully read this document before using this device, and strictly observe rules in this document when using this device.

	It alerts you to moderate dangers which, if not avoided, may cause minor or moderate injuries.
	It alerts you to risks. Neglect of these risks may cause device damage, data loss, device performance deterioration, or unpredictable results.
	It provides additional information.

WARNING

Strictly observe installation requirements when installing the device. The manufacturer shall not be held responsible for device damage caused by users' non-conformance to these requirements.

Strictly conform to local electrical standards.

The voltage must meet input voltage requirements for this device.

If this device is installed in places with unsteady voltage, ground this device to discharge high energy such as electrical surges in order to prevent the power supply from burning out.

Do not expose internal components to water or moisture.

Do not focus strong light (such as lighted bulbs or sunlight) on this device. Otherwise, the service life of the image sensor may be shortened.

If this device is installed in places where thunder and lightning frequently occur, ground the device nearby to discharge high energy such as thunder strikes in order to prevent device damage.

CAUTION

- Avoid heavy loads, intensive shakes, and soaking to prevent damages during transportation and storage. The warranty does not cover any device damage that is caused during secondary packaging and transportation after the original packaging is taken apart.
- Protect this device from dropping, keep the device away from magnetic field interference, and do not install the device in places with unstable surfaces.
- Clean the device with a soft dry cloth. For stubborn dirt, dip the cloth into slight neutral cleanser, gently wipe the dirt with the cloth, and then dry the device.
- Keep the device away from heat sources such as radiators, electric heaters, or other heat equipment.
- Keep the device away from moist, dusty, extremely hot or cold places, or places with strong electric radiation.
- Remove the power plug if the device is idle for a long time.

Special Announcement

- The manufacturer will update this manual according to product function enhancement or changes. Update information will be added to new versions of this manual without prior notice.
- This manual is only for reference and does not ensure that the information is totally consistent with the actual product. For consistency, see the actual product.

NOTE

For more information, please refer to website: www.libertyonline.com

1 Open Package Examination

Open the package, check the appearance of product for no obvious damage, and confirm the item list for table 1-1 is consistent.

Table 1-1 Packing list

Component	Quantity	Remark
Bullet HDVI Camera	1	
Quick Setup Guide	1	
Installation location sticker	1	
L wrench	1	
Black stainless self-tapping screw PA4.0×35mm	3	Alternative
Swell plastic button S8×30mm		
Black stainless self-tapping screw PA4.0×35mm	4	Alternative
Swell plastic button S8×30mm		

Supplier's Declaration of Conformity

Supplier's Declaration of Conformity
47 CFR § 2.1077 Compliance Information Unique Identifier: LA5BIR80

Responsible Party – U.S. Contact Information: Liberty Wire & Cable, Inc.
1490 Garden of the Gods Rd, Ste F Colorado Springs, CO 80907 855.388.7422

Warranty:

The manufacturer warrants this product to be free from defects in workmanship and materials, under normal use and conditions, for a period of three (3) years from the original invoice date.

2 Device Structure

2.1 Power and video cables

NOTE

Different device may have different power cable, please refer to the actual product.

Figure 2-1 Power and video cable

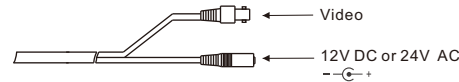

Connect the BNC connector of the power or video cable to a video signal cable and connect the other connector to a low-voltage power cable (12V DC or 24V AC). After installing the camera, directly connect the video cable and power cable.

2.2 Function Keys

Users can call OSD main menus through multi function switch control keys, and check and set camera parameters, function keys is shown as figure 2-2.

Figure 2-2 Function keys

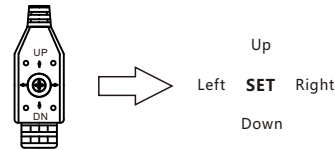

Operation description

SET key: It is used to enter OSD menus or select menu items when you press this key in the middle of the multi function switch.
UP/DOWN keys: The UP and DOWN keys are used to select menu items upwards and downwards by prodding the multi function switch upwards and downwards, the menu items rapidly roll upwards and downwards accordingly.
LEFT/RIGHT keys: The LEFT and RIGHT keys are used to select menu items horizontally or modify parameters by prodding the multi function switch towards the left or the right, the parameter values will rapidly decrease or increase.
Press and hold the LEFT button for 5s to switch to AHD mode. Press and hold the RIGHT button for 5s to switch to TVI mode. Press and hold the UP button for 5s to switch to CVBS mode. Press and hold the DOWN button for 5s to switch to CVI mode.

NOTE

The detail operation of OSD please refer to *Camera OSD Operation Guide*.

2.3 Camera Dimensions

NOTE

Different device may have different dimensions, please refer to the actual product.

Figure 2-3 Zoom lens Dimensions 1 (Unit:mm)

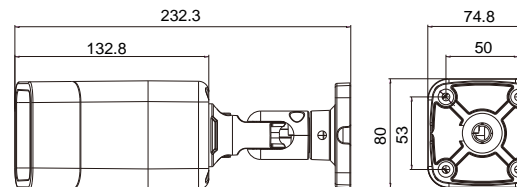

3 Device Installation

The Camera can be installed on the ceiling or wall. If the camera is installed on a concrete wall, install the plastic anchors before installing the bracket. If the camera is installed on a wooden wall, use self-tapping screws to install the bracket directly.

Figure 4-1 Installing camera

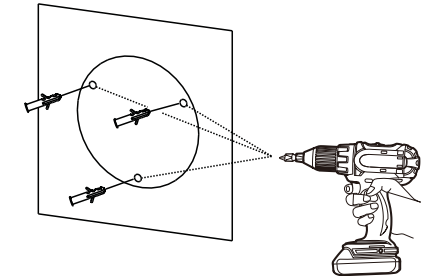

Installation Steps:

Step 1 Stick the Installation location sticker on the ceiling or wall, Drill three holes based on the marks on the sticker. Drive the swell plastic buttons into the holes.

Step 2 Connect the BNC cable.

NOTE

you can route cables from the top or from aside. If you use the top routing method, drill a hole in the surface first. If you use the aside routing method. When you route cables from aside, Please route the multi-head cable out from the side gap at the bottom of the camera.

Step 3 Install the camera on the ceiling or wall, and fix the screws as shown in figure 4-5.

Figure 4-5 Installing camera

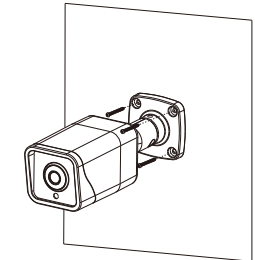

Step 4 Loosen the fixing screw and locking ring to adjust the position so that the camera faces the monitored area, then tighten the locking ring and the fixing screw, as shown in figure 4-6.

Figure 4-6 Adjusting the monitoring direction

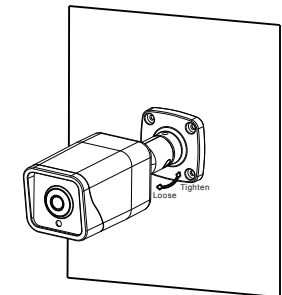



LA5VFDIR100IN LA5VFDIR100

Quick Guide

this device. Otherwise, the service life of the image sensor may be shortened.

- If this device is installed in places where thunder and lightning frequently occur, ground the device nearby to discharge high energy such as thunder strikes in order to prevent device damage.

CAUTION

- Avoid heavy loads, intensive shakes, and soaking to prevent damages during transportation and storage. The warranty does not cover any device damage that is caused during secondary packaging and transportation after the original packaging is taken apart.
- Protect this device from fall-down and intensive strikes, keep the device away from magnetic field interference, and do not install the device in places with shaking surfaces or under shocks.
- Clean the device with a soft dry cloth. For stubborn dirt, dip the cloth into slight neutral cleanser, gently wipe the dirt with the cloth, and then dry the device.
- Do not jam the ventilation opening. Follow the installation instructions provided in this document when installing the device.
- Keep the device away from heat sources such as radiators, electric heaters, or other heat equipment.
- Keep the device away from moist, dusty, extremely hot or cold places, or places with strong electric radiation.
- If the device is installed outdoors, take insect- and moisture-proof measures to avoid circuit board corrosion that can affect monitoring.
- Remove the power plug if the device is idle for a long time.

1 Open Package Examination

Open the package, check the appearance of product for no obvious damage, and confirm the item list for table 1-1 is consistent.

Table 1-1 Packing list

Component	Quantity	Remark
HDVI Dome Camera	1	
Quick Setup Guide	1	
T15 Screw driver	1	Optional
M3 Screw driver	1	
Plug wrench	1	Optional
Installation location sticker	1	Optional
Stainless self-tapping screw PA4.0×30mm	3	
Swell plastic buttonφ5.6×29mm	3	
Black screw PA3.2×70mm	3	Optional

2 Device Structure

NOTE

Different device may have different power cable, please refer to the actual product.

2.1 Power and video cables

Figure 2-1 Power and video cable

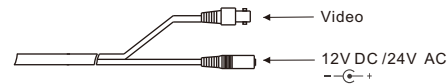

Connect the BNC connector of the power or video cable to a video signal cable and connect the other connector to a low-voltage power cable (12V DC / 24V AC). After installing the camera, directly connect the video cable and power cable.

2.2 Function Keys

Users can call OSD main menus through multi function switch control keys, and check and set camera parameters, function keys is shown as figure 2-2.

Figure 2-2 Function keys

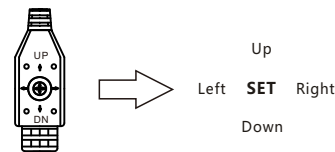

Operation description

2.2.1 Camera without PTZ

SET key: It is used to enter OSD menus or select menu items when you press this key in the middle of the multi function switch.
UP/DOWN keys: The UP and DOWN keys are used to select menu items upwards and downwards by prodding the multi function switch upwards and downwards, the menu items rapidly roll upwards and downwards accordingly;
LEFT/RIGHT keys: The LEFT and RIGHT keys are used to select menu items horizontally or modify parameters by prodding the multi function switch towards the left or the right, the parameter values will rapidly decrease or increase.
 Press and hold the LEFT button for 5s to switch to AHD mode.
 Press and hold the RIGHT button for 5s to switch to TVI mode.
 Press and hold the UP button for 5s to switch to CVBS mode.
 Press and hold the DOWN button for 5s to switch to CVI mode.

2.2.2 Camera with PTZ

Press SET button and hold for 5s, the modes switch as follows: Pan/Tilt, Zoom, Camera.

Figure 2-3 Set keys for PTZ

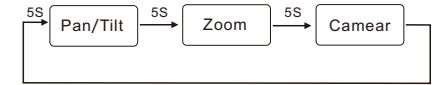

Pan/Tilt: Press Up/Down/Left/Right to control the horizontal and vertical rotation.

Zoom mode: Press Up/Down/Left/Right to control the lens and focus.

Camera Mode: Press SET to camera OSD Menu. Press and hold the LEFT button for 5s to switch to TVI mode. Press and hold the RIGHT button for 5s to switch to CVBS mode. Press and hold the UP button for 5s to switch to AHD mode. Press and hold the DOWN button for 5s to switch to CVI mode.

NOTE

The detail operation of OSD please refer to *Camera OSD Operation Guide*.

2.3 Camera Dimensions

NOTE

Different device may have different dimensions, please refer to the actual product.

Figure 2-4 Dimensions (Unit:mm)

Ceiling installation

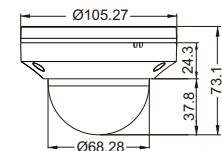

Wall installation

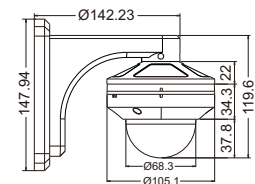

Precautions

Fully understand this document before using this device, and strictly observe rules in this document when using this device. If you install this device in public places, provide the tip "You have entered the area of electronic surveillance" in an eye-catching place. Failure to correctly use electrical products may cause fire and severe injuries.

WARNING	It alerts you to moderate dangers which, if not avoided, may cause minor or moderate injuries.
CAUTION	It alerts you to risks. Neglect of these risks may cause device damage, data loss, device performance deterioration, or unpredictable results.
NOTE	It provides additional information.

WARNING

- Strictly observe installation requirements when installing the device. The manufacturer shall not be held responsible for device damage caused by users' non-conformance to these requirements.
- Strictly conform to local electrical safety standards and use power adapters that are marked with the LPS standard when installing and using this device. Otherwise, this device may be damaged.
- Use accessories delivered with this device. The voltage must meet input voltage requirements for this device.
- If this device is installed in places with unsteady voltage, ground this device to discharge high energy such as electrical surges in order to prevent the power supply from burning out.
- When this device is in use, ensure that no water or any liquid flows into the device. If water or liquid unexpectedly flows into the device, immediately power off the device and disconnect all cables (such as power cables and network cables) from this device.
- Do not focus strong light (such as lighted bulbs or sunlight) on

Special Announcement

- All complete products sold by the manufacturer are delivered along with nameplates, quick setup guide and accessories after strict inspection. The manufacturer shall not be held responsible for counterfeit products.
- The manufacturer will update this manual according to product function enhancement or changes and regularly update the software and hardware described in this manual. Update information will be added to new versions of this manual without prior notice.
- This manual may contain misprints, technology information that is not accurate enough, or product function and operation description that is slightly inconsistent with the actual product, the final interpretation of company is as a standard.
- This manual is only for reference and does not ensure that the information is totally consistent with the actual product. For consistency, see the actual product.

NOTE

For more information, please refer to website.

Figure 2-5 Dimensions (Unit:mm)

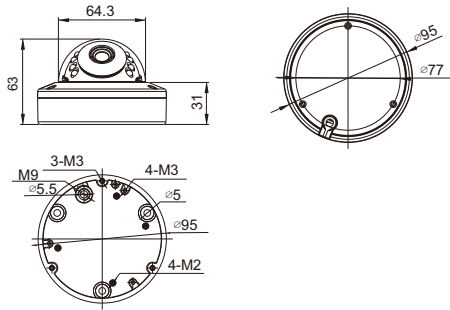

Figure 2-6 Plastic Dome Dimensions (Unit:mm)

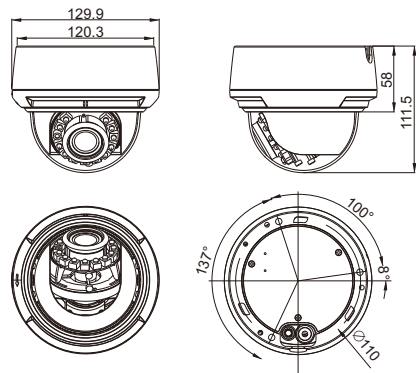
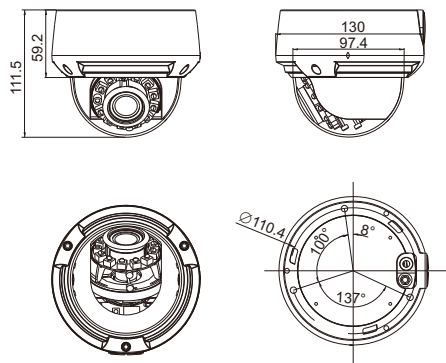

Figure 2-7 Vandal dome Dimensions (Unit:mm)



3 Device Installation

WARNING

To avoid moisture influence, install the dome cover at least half an hour after the camera is installed and powered on.

The vandal dome camera can be installed in the ceiling, wall, wall bracket or ceiling bracket. This section describes how to install the camera in the ceiling.

3.1 Installation for camera in Figure 2-6.

- Step 1 Stick the Installation location sticker on the ceiling or wall, Drill three holes based on the marks on the sticker. Drive the swell plastic buttons into the holes.
- Step 2 Fix shell with screws to the ceiling directly for ceiling installation, as shown in Figure 3-1. Install bracket mount plate to the ceiling or wall with screws for wall installation, as shown in Figure 3-2.

Figure 3-1 Ceiling installation

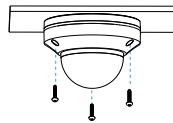
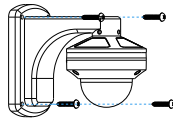

Figure 3-2 Wall installation



- Step 3 Detach protection vinyl from the dome cover.

3.2 Installation for other cameras.

- Step 1 Remove the upper cover. For Plastic dome, press down the dome with one hand at position marked by an arrow, rotate the upper cover of the dome counterclockwise with the other hand, and gently pull the upper cover upward to remove it, as shown in Figure 3-3. For vandal dome, use the T15 screw driver in the accessory package to unscrew the three screws on the dome cover. The camera is opened, as shown in figure 3-3.

Figure 3-3 Opening camera



- Step 2 Stick the Installation location sticker on the ceiling or wall, Drill three holes based on the marks on the sticker. Drive the swell plastic buttons into the holes.
- Step 3 Connect the multi-head cable (If camera base installation and aside routing selected, this step is operated after step 5).
- Step 4 If camera housing installation applied, Fetch three black self-tapping screws from the accessory package. Then fix the screws to fasten the camera on the ceiling as shown in figure 3-4.

Figure 3-4 Installing housing

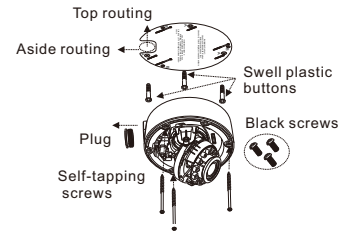

- Step 5 If camera base installation applied, press the arrows marked on the lining to remove the lining aside. Unscrew the three black screws and put them aside. Turn the camera base clockwise for 5 degrees and remove it, as shown in figure 3-5.

Figure 3-5 Removing lining and base

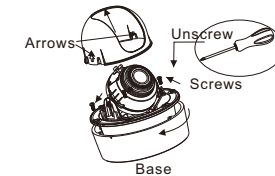

- Step 6 Aim the three through-holes on the camera base at the three swell plastic buttons in the ceiling, and use screws with a length of 30 mm to fix the base on the ceiling. Turn the main body clockwise for about 5 degrees to assembly it with the camera base, and fix the three screws, as shown in figure 3-6.

Figure 3-6 Installing base

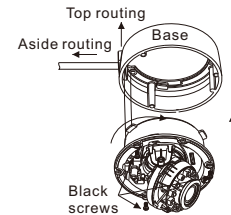

- Step 7 View the video, adjust the lens angle horizontally and vertically, Set the value in the Front-end Configuration for AF lens and use the focusing lever for MF lens to adjust the lens Focal length and video angle range.

Figure 3-7 Adjusting lens

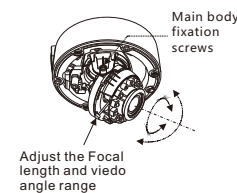

- Step 8 Assemble the lining with the main body and buckle the four button placements with the main body bracket. Then fasten the dome cover, as shown in Figure 3-8.

Figure 3-8 Assembling lining and base

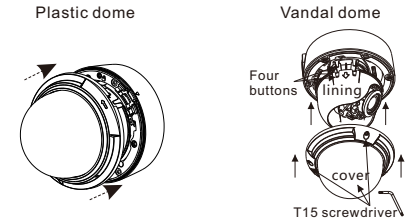

3.3 Embedded Installation for plastic dome

- Step 1 Remove the upper cover and the lower cover.
- Step 2 Take the embedded installation location sticker, drill a hole basing on the inner edge of the sticker.
- Step 3 Put into the hole with one hand, and attach it to the installation surface, hold the dome with one hand, and fasten the screws with the other hand till touches the inner side of the installation surface, and fasten the dome, as shown in figure 3-9.

Figure 3-9 Embedded Installation

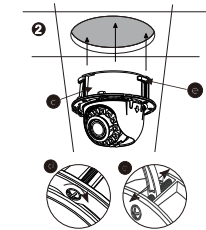

- Step 4 Take the video patch cord out of the accessory, connect the RCA end of the line to the second video output port, and connect the BNC end of the line to a monitor for tests.

NOTE

By default, the focusing lever is locked. To adjust the focusing lever, loosen it in counterclockwise direction and then tighten it after adjustment.

- Step 5 Remove the lining and adjust the angle of the camera, fix the focusing lever, and adjust the lens angle as required.
- Step 6 Install the lining and the upper cover.

4 Supplier's Declaration of Conformity

Supplier's Declaration of Conformity

47 CFR § 2.1077 Compliance Information Unique Identifier: LA5VFDIR100, LA5VFDIR100IN

Responsible Party – U.S. Contact Information: Liberty Wire & Cable, Inc. 1490 Garden of the Gods Rd, Ste F Colorado Springs, CO 80907 855.388.7422

Warranty:

The manufacturer warrants this product to be free from defects in workmanship and materials, under normal use and conditions, for a period of three (3) years from the original invoice date.